

STRUCTURAL STRENGTHENING



STRUCTURAL SAFETY IN THE BUILDING SECTOR

Structural safety has become a widely debated topic in the building sector and more and more resources are being dedicated to this issue, particularly retrofitting existing structures with structural strengthening packages.

The seismic vulnerability of buildings in particular has been under much discussion, especially over the last few decades, following the numerous seismic events that have hit areas with a stock of old buildings. Most of today's existing buildings were built during periods in which building regulations and standards did not fully provide for the effect of horizontal stresses generated by seismic inertia forces. And it is for this precise reason that, even though they were designed and built according to regulations and standards in act at the time, many of these structures were badly damaged by earthquakes that occurred at a later date.

The strengthening of existing structures, however, is not limited to problems caused by seismic events. In fact, structures may be affected by various types of problems, such as:

- deterioration of the materials used to make the structure (corrosion of steel reinforcement, deteriorated concrete, deteriorated masonry, etc.);
- a change in use of a structure leading to a modification of its configuration or of the loads acting on it;
- simply increasing the loads acting on the structure;
- other unforeseen events (such as fire, geological instabilities, impact loads, etc.);
- subsidence.

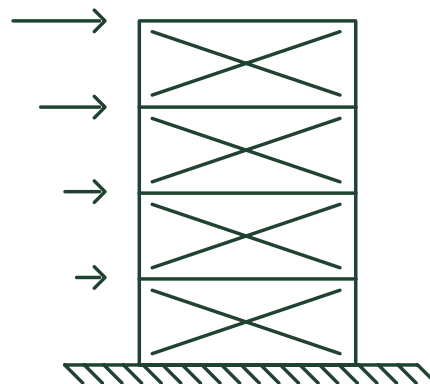

As a result, **numerous scientific studies and the development of innovative materials have been key elements in the development of new technologies** designed to strengthen existing structures, **particularly in the last few decades.**

And in this field, too, for more than 20 years Mapei has played a key role in the development of new techniques, the result of highly productive collaboration between the company's internal R&D laboratories and numerous Italian and foreign universities.

The development process has been driven by the evolution of standards and technologies following major seismic events around the world which, in turn, has led to the development of strengthening systems specific for each different type of problem.

The **first part** of the manual contains an overview of the principal strengthening technologies adopted. Each one will include the various areas of use for that particular technology, the advantages of adopting that particular technology and the relative scientific research related to it.

The **second part**, on the other hand, features practical applications of the various technologies described in the first part, according to the structural configuration of the building to be strengthened, in order to highlight their most important application aspects.

MAPEI: technological innovation in constant evolution



FRP SYSTEM



FRG SYSTEM



HPC SYSTEM



MAPEWRAP
EQ SYSTEM

OUR EXPERIENCE

FOLLOWING MAJOR EARTHQUAKES

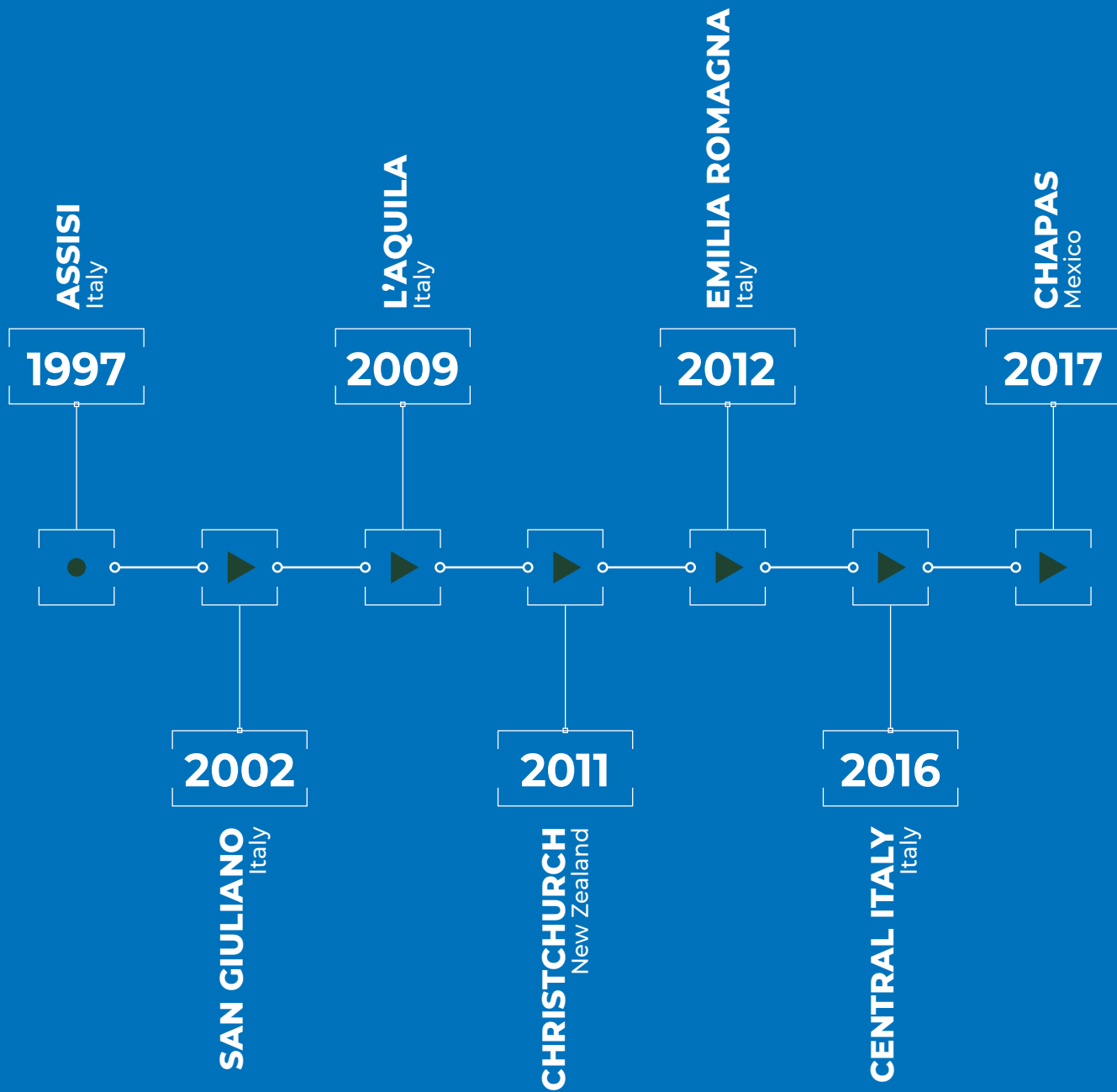



MAPEI AROUND THE WORLD

BASILICA OF SAN FRANCESCO D'ASSISI
Assisi - Italy - 1998

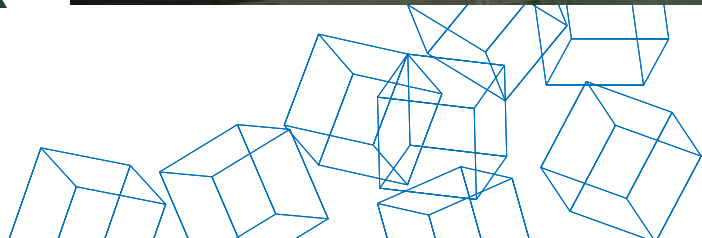

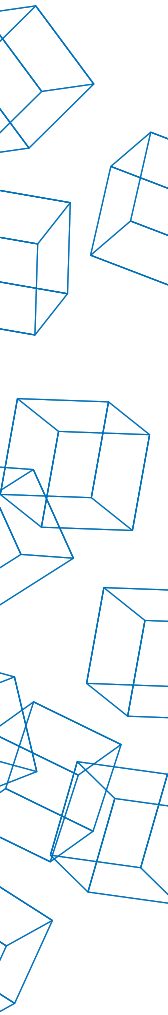

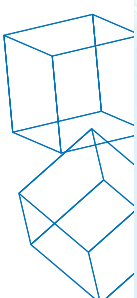
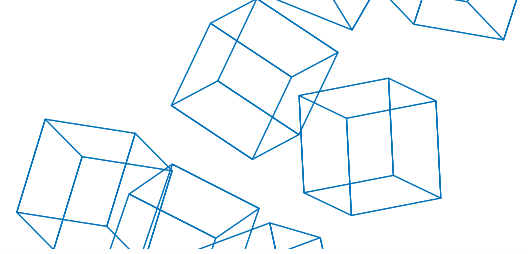

HOUSING & DEVELOPMENT BOARD
Singapore | 2013



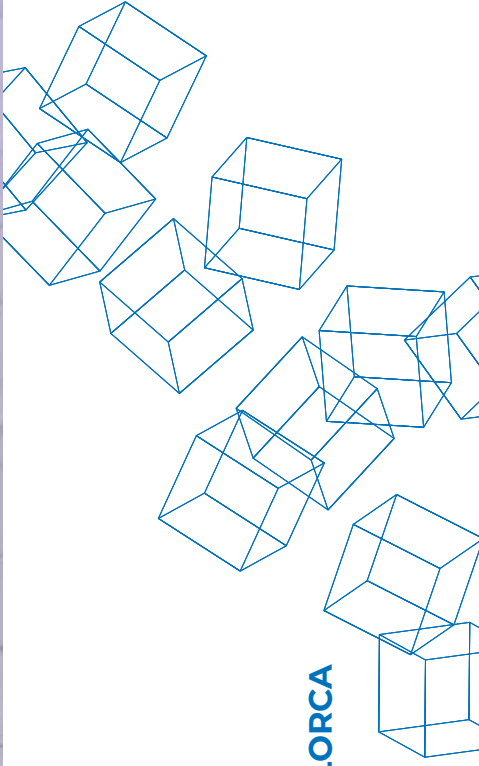

IGLESIA DE SAN CRISTÓBAL EN LORCA
Spain - 2013



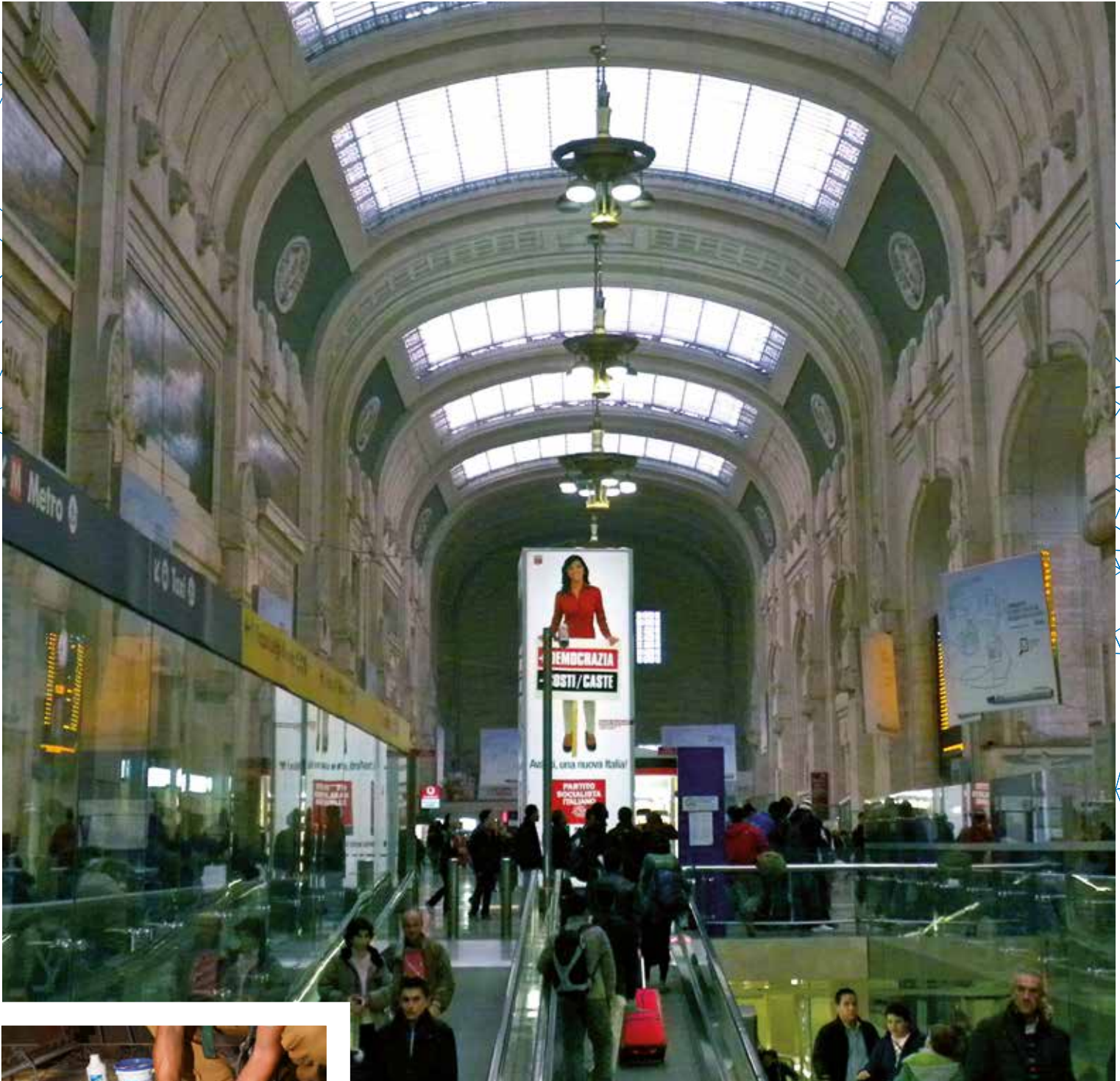

MILAN CENTRAL STATION
Milan - Italy - 2007



**APSE OF SANTA MARIA ANNUNZIATA
CATHEDRAL IN CAMERINO**
Camerino - Italy - 2017

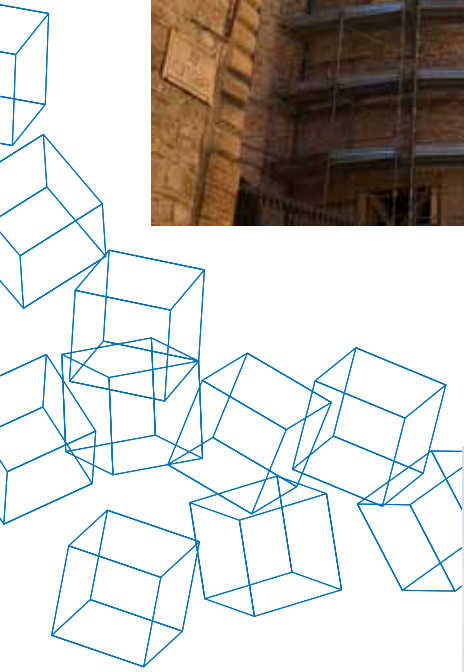

CHAMPLAIN BRIDGE MONTREAL
Quebec - 2013



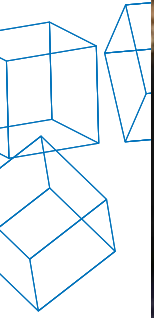
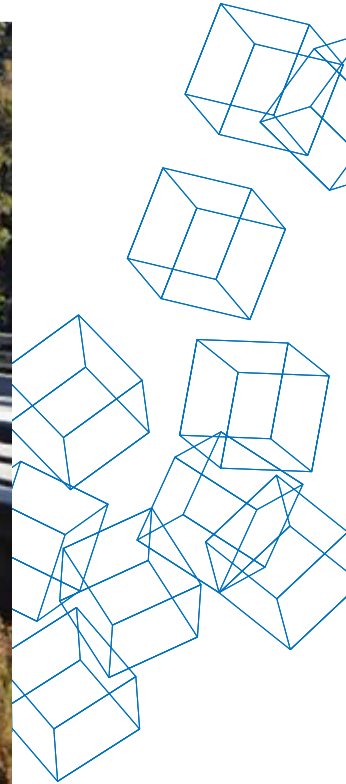

SHALE PEAK BRIDGE
New Zealand - 2015

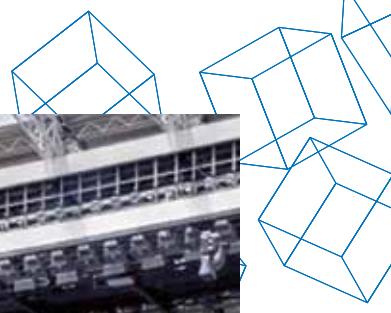
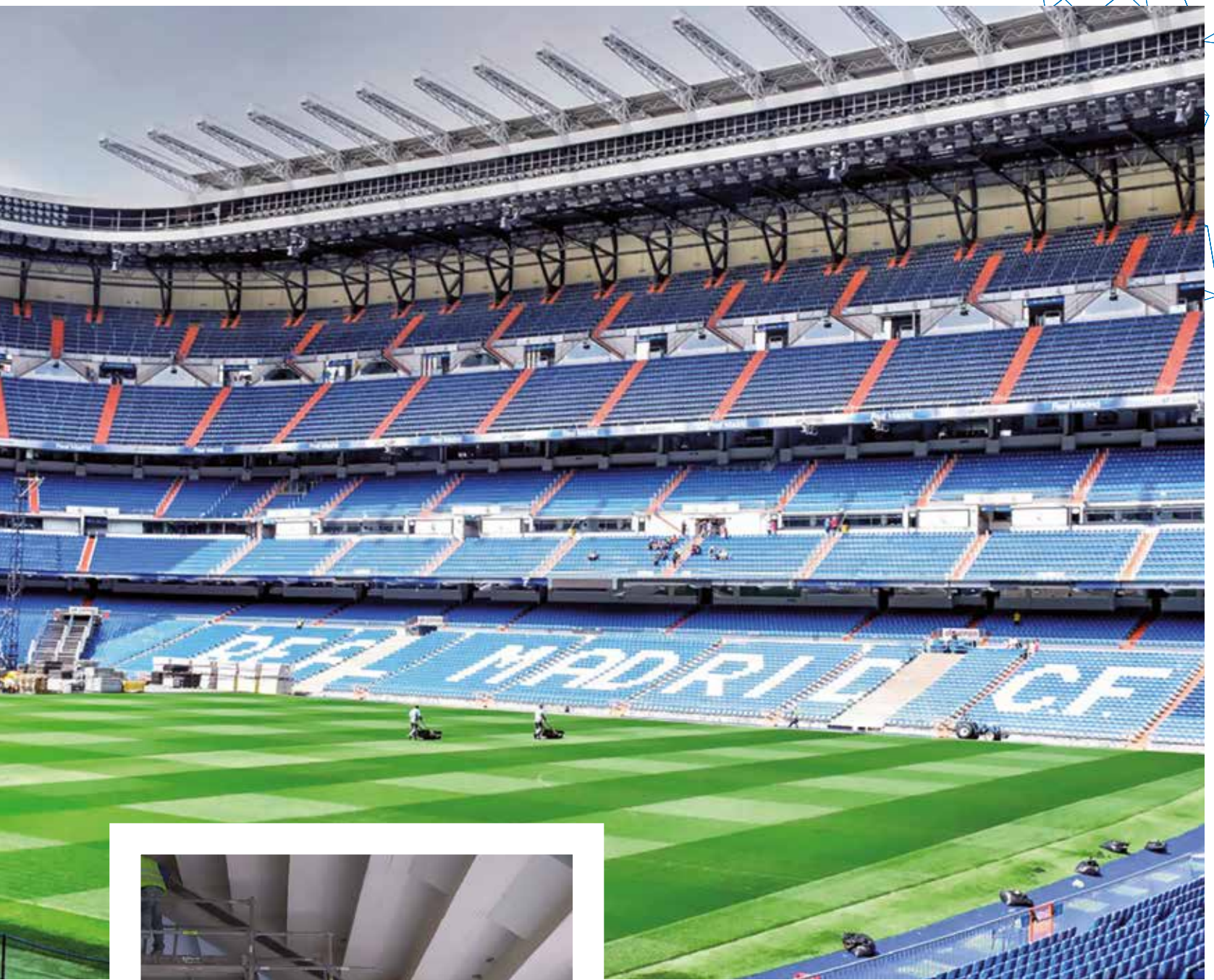

SANTIAGO BERNABEU
Madrid - Spain - 2011



UNIVERSIDAD NACIONAL AUTÓNOMA DE MÉXICO
Mexico - 2018



CHURCH OF ST. JOHN THE BAPTIST
Croatia - 2016



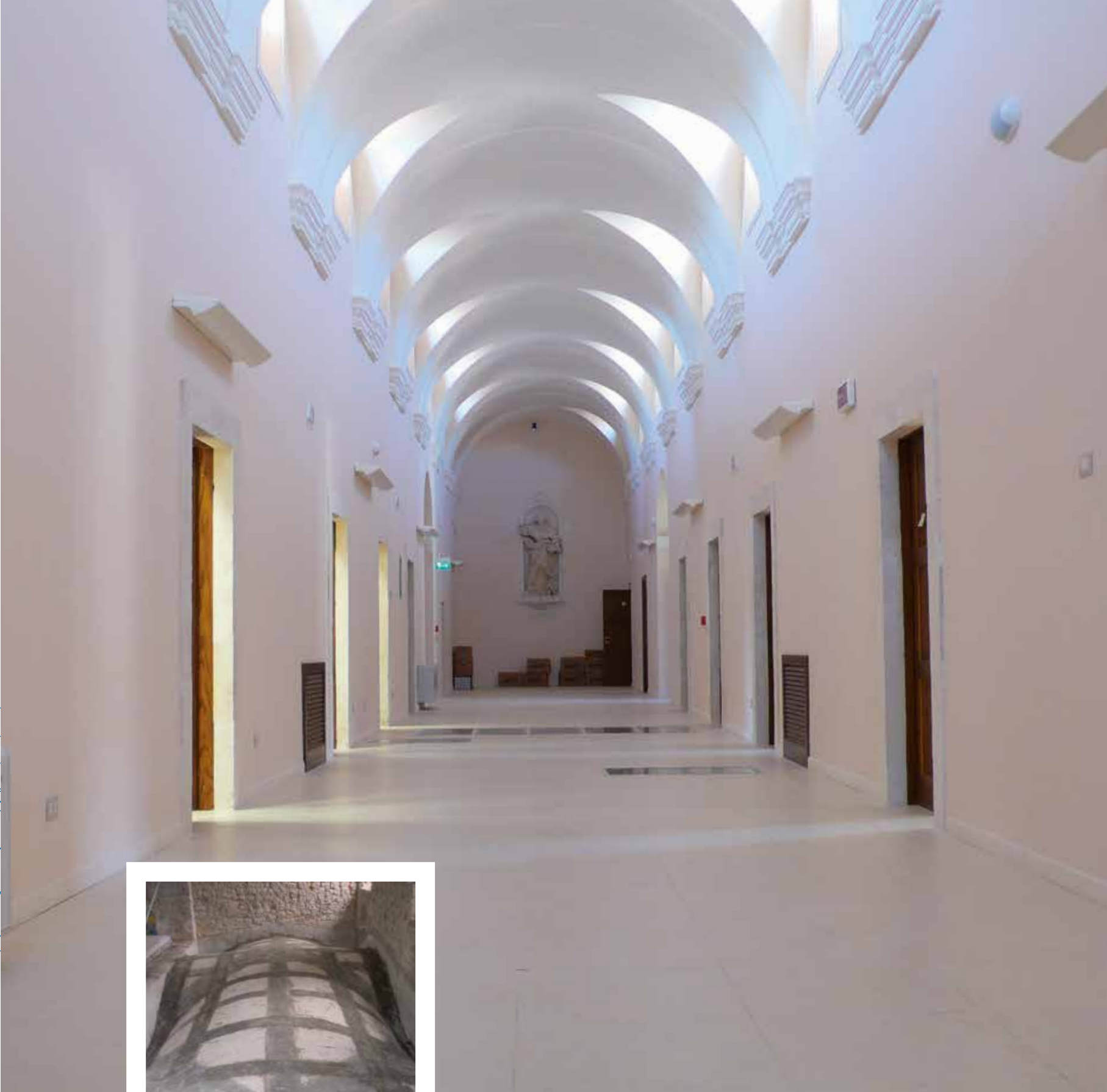

↓
FORMER CONVENT OF SAN DOMENICO
L'Aquila - Italy - 2008

INDEX

01 . MAPEI TECHNOLOGIES

1.1	FRP SYSTEM	18
1.1.1	DEFINITION	18
1.1.2	TYPES OF MATERIAL AND AREAS OF USE	20
1.1.3	EXPERIMENTAL TESTING	26
1.2	FRG SYSTEM	36
1.2.1	DEFINITION	36
1.2.2	TYPES OF MATERIAL AND AREAS OF USE	37
1.2.3	EXPERIMENTAL TESTING	42
1.3	HPC SYSTEM: HIGH-PERFORMANCE FIBRE-REINFORCED CEMENTITIOUS MORTAR (FRC)	50
1.3.1	DEFINITION	50
1.3.2	TYPES OF MATERIAL AND AREAS OF USE	52
1.3.3	EXPERIMENTAL TESTING	60

1.4	MAPEWRAP EQ SYSTEM	64
1.4.1	DEFINITION, MATERIALS AND AREAS OF USE	64
1.4.2	EXPERIMENTAL TESTING	66
1.5	COMPLEMENTARY SYSTEMS	68
1.5.1	STAINLESS STEEL HELICAL BARS	68
1.5.2	CHEMICAL ANCHORS	69
1.5.3	INJECTION SYSTEMS FOR MASONRY	71
1.5.4	MAPEWRAP FIOCCO	73
1.5.5	MAPEWRAP CONNECTOR	74
1.5.6	EXPERIMENTAL TESTING	75

02 . **TECHNICAL SOLUTIONS** STRENGTHENING SYSTEMS SHEETS

2.1	STRENGTHENING SYSTEMS FOR REINFORCED CONCRETE BUILDINGS	78
2.2	STRENGTHENING SYSTEMS FOR MASONRY AND WOODEN BUILDINGS	116
2.3	STRENGTHENING SYSTEMS FOR NON-LOAD-BEARING ELEMENTS	162



STRUCTURAL STRENGTHENING





MAPEI

TECHNOLOGIES



1.1 FRP SYSTEM

1.1.1

DEFINITION

Fibre-Reinforced Polymers, more commonly known as FRP, cover an extensive range of composite materials with an organic polymer matrix (epoxy resin) that is used to impregnate a long, continuous strengthening material made from high-strength fibres.

As can be seen in the photo taken through an electron microscope at the MAPEI R&D laboratories, FRP composite materials are made up of two distinct elements, fibres and a matrix, with two different functions: the fibres withstand the stresses and loads, while the matrix transfers the stresses and loads from the element to be strengthened to the strengthening fibres. The use of FRP has been consolidated practice in the aeronautics, naval and mechanical engineering sectors for a number of years and has now become widely adopted in the building industry, particularly in the field of strengthening systems for existing structures.

They were first introduced at the end of the 1980's and their use became more widespread thanks to scientific research and testing carried out over the years, extensive trials in the field to improve and perfect application methods and the development of more comprehensive standards and guidelines governing their use. Because they are so widely used, FRP systems should no longer be defined as an "innovative" strengthening solution, but should be considered a "common" type of structural strengthening intervention, particularly in the seismic upgrading field.

→ An image of FRP composite materials through a microscope.

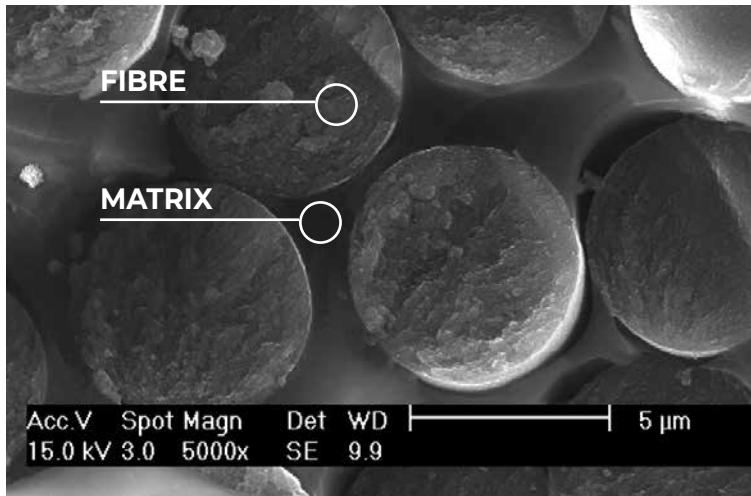

FRP represent an improvement on other traditional techniques available thanks to the numerous benefits they offer, which may be summarised as follows:

- high resistance to chemicals and durability over the years;
- improvement of the mechanical properties of strengthened elements without increasing their mass or the rigidity of structures. These characteristics are a fundamentally important advantage, particularly when carrying out strengthening work for seismic purposes;
- unlike traditional strengthening systems (increasing the section of elements, adding beam-props, beton plaquè, etc.), the layers applied are more compact and do not alter the appearance of the structure or change the original geometry of the structure;
- increase of the structure's ductility;
- quick and easy installation;
- reversibility of the strengthening work.

FRP, for example, may be used on structures subject to deflection instead of traditional jacketing systems using steel plates: replacing steel plates (which are heavy, become corroded quite quickly and need to be bolted to the structure) with sheets of FRP is an example of technological progress and it allows the problem of corrosion to be eliminated, makes installation work much easier, reduces the amount of time required to carry out the work and the intervention does not modify the dimensions of the strengthened element.

Contrary to what one may think, FRP systems are also beneficial from an economic point of view.

Because of their low weight, installation does not require special equipment or lifting gear, only a small workforce is required, installation can be carried out very quickly and, in many cases, it is not even necessary to interrupt the normal activities of the structure itself. As a result, installation of these types of system reduces application times and the amount of equipment required to carry out the work.

FRP represent an improvement on other traditional techniques available thanks to the numerous benefits they offer.

1.1.2

TYPES OF MATERIAL

AND AREAS OF USE

The constant progress in FRP materials is driven by the continuous development of fibres with different mechanical properties, with the capacity to provide an even better response to numerous technical and application requirements.

In fact, the fibres used may be of various nature (carbon, glass, basalt, aramid) and may have different mechanical properties (tensile strength, modulus of elasticity, elongation at failure), as well as different physical-chemical properties (resistance to corrosion, etc.).

Thanks to the company's twenty years of experience in the world of FRP, MAPEI is able to provide a complete range of composite materials made up of various types of resin and fibres.

FRP systems from the MAPEI range are divided into macro-families as follows.



MAPEWRAP SYSTEM

MAPEWRAP SYSTEM: structural strengthening system consisting of high-strength, high-modulus fabric in carbon fibre, glass fibre or basalt fibre and epoxy resins to impregnate and bond the fabric. The possibility to orientate and dose the strengthening fibres in the same direction in which the stresses and loads act on a member or structure means that specific types of fabric can be produced, and that they are able to operate in conditions and achieve results that would be unthinkable using traditional strengthening systems.

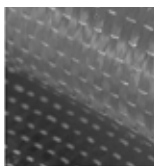
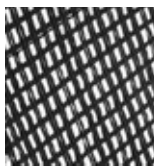

MAPEWRAP C carbon fibre fabrics

Direction of fibres	UNI-Directional		BI-Directional	QUADRI-Directional
				
Tensile modulus of elasticity	252 GPa	390 GPa	230 GPa	230 GPa
Weight	300 and 600 g/m ²	300 and 600 g/m ²	230, 300 and 360 g/m ²	380 g/m ²

MAPEWRAP G glass fibre fabric

MAPEWRAP B basalt fibre fabric

MAPEWRAP S FABRIC steel fibre fabric

Direction of fibres	UNI-Directional	UNI-Directional	UNI-Directional	
				
Tensile modulus of elasticity	80 GPa	89 GPa	230 GPa	
Weight	900 g/m ²	400 and 600 g/m ²	650 g/m ²	2000 g/m ²

In certain cases it is possible to use various types of fabric made from steel fibres (**MAPEWRAP S FABRIC**) in combination with a polymer matrix. This type of system, however, is not included in the Calculation Instructions contained in CNR DT 200 R1/2013 (which replaces the National Guidelines for Designing FRP Strengthening).



Strengthening of a beam-pillar joint with
MAPEWRAP C SYSTEM
– i Guzzini



MAPEWRAP SYSTEM:
fabric in carbon fibre,
glass fibre or basalt
fibre and epoxy resins
for bonding purposes.



Strengthening of a brickwork chimney with
MAPEWRAP C SYSTEM
– Villaggio Crespi d'Adda

CARBOPLATE SYSTEM

CARBOPLATE SYSTEM: structural strengthening system consisting of pultruded plates in high-strength carbon fibre and epoxy resins for bonding purposes. The system may be made up of different types of plate based on their modulus of elasticity and dimensions.

CARBOPLATE | pultruded carbon fibre plates

	CARBOPLATE E 170	CARBOPLATE E 200	CARBOPLATE E 250
			
Tensile modulus of elasticity	≥ 160 GPa	≥ 190 GPa	250 GPa
Sizes available	50, 100 and 150 mm standard width rolls		



Flexural strengthening of beams and a floor with CARBOPLATE SYSTEM



CARBOPLATE SYSTEM: pultruded sheets in high-strength carbon fibre and epoxy resins for bonding purposes.



Application of CARBOPLATE SYSTEM on brick-cement floor joists





Flexural strengthening of a wooden beam by cladding with CARBOPLATE SYSTEM

MAPEROD SYSTEM

MAPEROD SYSTEM: high-tensile, improved adherence, pultruded bars in carbon fibre or glass fibre and epoxy resins for bonding purposes for structural strengthening of concrete, wooden and masonry elements.

MAPEROD C
carbon fibre bars

MAPEROD G
glass fibre bars

		
Tensile modulus of elasticity	155 GPa	40.8 GPa
Diameters available	10-12 mm	10 mm
Tensile strength	2000 MPa	760 MPa
Packaging	Boxes of 10 x 2 m bars	Boxes of 10 x 6 m bars



MAPEROD SYSTEM: high-tensile pultruded bars and epoxy resins for bonding purposes.



Strengthening of a wooden beam with MAPEROD SYSTEM



Reference norms and standards

the guidelines for the design of FRP strengthening are the Instructions found in CNR-DT 200 R1/2013 (a revision of the original CNR DT200/2004 document) “Instructions for the Design, Execution and Control of Static Consolidation Interventions using Fibre-reinforced Composites – Materials, reinforced concrete, prestressed concrete and masonry structures”, and adopted in full as the Guidelines of the C.S.LL.PP. (Central Technical Service of the Supreme Council of Public Works) since 2009.

These instructions were written by combining the knowledge and experience of manufacturers, users (designers and contractors) and experts from the academic world by following an approach to safety aspects in line with the relative, applicable Eurocodes.

Indications for the qualification of systems and of their acceptance on site, on the other hand, are contained in the document “Guidelines for the identification, qualification and acceptance criteria for fibre-reinforced composites with a polymer matrix (FRP) used in the structural consolidation of existing structures”, which was issued by the C.S.LL.PP through the DPCS LL.PP statute No. 293 on 29.05.2019 (a revision of the original document No. 220 on 9.7.2015). This document is aimed mainly at manufacturers of these types of systems, who must demonstrate the validity of any solution they propose, and to Directors of Works, who are responsible for controlling and accepting the materials on site.

The Central Technical Service (STC) of the C.S.LL.PP then issues Manufacturers with a Technical Evaluation Certificate (CVT) (the former CIT NTC 2008) for the FRP strengthening system based on the said Guidelines.

Calculation approach

The design of strengthening work must be based on the results obtained from a preliminary analysis of the existing structure.

The performance properties of existing structures exposed to seismic loads may be improved by either improving the response capacity of a structure or by limiting the amount of load acting on a structure during an earthquake.

Designing a strengthening package that includes FRP may be classed as a selective type of intervention and is aimed at intervening on certain elements of a structure to improve its performance properties, particularly ductility, while preventing fragile collapse mechanisms.

Problems due to irregularities in a structure’s rigidity cannot be overcome by using FRP. Irregularities in the strength of a structure, on the other hand, can be overcome by strengthening targeted elements of the structure, but always making sure that its overall ductility is not compromised.

ACTION	NORM / STANDARD	MAPEI INSTRUMENT
Qualification	FRP Guidelines (DPCSLLPP No. 293 29/05/2019) (DPCSLLPP No. 220 09/07/2015)	CIT / CVT certificate
Design	CNR-DT 200 R1/2013 (CSLLPP Guidelines 24/07/2009)	MAPEI STRUCTURAL DESIGN
Site acceptance	FRP Guidelines (DPCSLLPP No. 293 29/05/2019) (DPCSLLPP No. 220 09/07/2015)	CIT / CVT certificate

1.1.3

EXPERIMENTAL TESTING



Project funded by the Campania Region – Plurifund Operational Programme 5.4.3 - 1999 – band II

Experimental testing on brick-concrete floors strengthened with plates of CFRP

YEAR: 1999 - 2001

LOCATION: EDIL-TEST S.R.L. LABORATORY - Viale delle Industrie - 84091 Battipaglia (Salerno)

LEAD RESEARCHERS: A. Balsamo, R. Erra, E. Erra

EXPERIMENTAL TESTING: 8 full-scale flat floors measuring 490 cm x 200 cm each were made using the most commonly adopted materials system (brick-concrete using various concrete classes), with the ends of each floor sitting on simple supports. Each floor was subjected to load tests, firstly in the “as-built” condition, and then after being strengthened with CFRP **CARBOPLATE** plates applied to the extrados of the floor joists.

RESULTS: The tests demonstrated that a strengthened floor has the same amount of maximum deflection as an “as-built” floor when up to twice the amount of load is applied.

REFERENCES:

“Experimental testing of resin and carbon fibre composite materials and their relative application techniques used in the structural consolidation of normal reinforced concrete elements and prestressed concrete elements” – Project funded by the Campania Region – Department of Universities and Scientific Research, Technological Innovation and New Economy, IT Systems and Statistics, Museums and Libraries – Plurifund Operational Programme 5.4.3 - 1999 – Band II, (1999 to 2001)





ICONS Project (Innovative seismic design concepts for new and existing structures)

Full-scale reinforced concrete building strengthened with CFRP

YEAR: 2001

LOCATION: ELSA Laboratory, Joint Research Centre, European Commission, Ispra (Varese)

LEAD RESEARCHERS: A. Balsamo, A. Colombo, G. Manfredi, P. Negro, A. Prota, P. Zaffaroni

EXPERIMENTAL TESTING: A full-scale reinforced concrete structure consisting of two parallel frames connected by rigid diaphragms, designed according to the rules of Eurocode 8 following the Displacement Based Design (Dbd) approach. The structure was initially subjected to two pseudo-dynamic tests, the first to simulate an earthquake and the second test to simulate an earthquake 1.5 times more powerful than the previous one. The frames were severely damaged and were repaired by filling the cracks and injecting them with epoxy resin of the appropriate viscosity. Following the repairs, strengthening was applied using uni-directional carbon fibre fabric (CFRP) to bind the pillars (**MAPEWRAP C UNI-AX**) and quadri-directional carbon fibre fabric to repair the partitions and beam-pillar joints (**MAPEWRAP C QUADRI-AX**).

RESULTS: The failure in the frame repaired and strengthened with CFRP was caused by the failure of the longitudinal steel reinforcement in the section at the base of the partitions, with complete detachment of the steel reinforcement from the foundations. Under seismic loading, the structure repaired and strengthened with CFRP had a very similar response to that of the original structure but exhibited higher deformation capacity. Also, unlike the original structure, it was able to withstand the effects of an earthquake 1.5 times more powerful than the design values.



REFERENCES:

A. Balsamo, A. Colombo, G. Manfredi, P. Negro, A. Prota, (2005). Seismic behaviour of a full-size RC frame repaired using CFRP laminates. *ENGINEERING STRUCTURES*, 10.1016/j.engstruct.2005.01.002

Balsamo A.; Colombo A.; Manfredi G.; Negro P.; Prota A. (2002). Full-Scale Test on a RC Dual System Repaired with Advanced Composites. *12th European Conference on Earthquake Engineering, London (UK)*, 9-13 September 2002

G. Manfredi; A. Prota; M. Pecce; A. Balsamo (2003). The use of composites in Reinforced Concrete Structures. *L'EDILIZIA* magazine



SPEAR Project (Seismic Performance Assessment and Rehabilitation of existing buildings)

Full-scale reinforced concrete building strengthened with GFRP

YEAR: 2001

LOCATION: ELSA Laboratory, Joint Research Centre, European Commission, Ispra (Varese)

LEAD RESEARCHERS: A. Balsamo, M. Di Ludovico, G. Manfredi, A. Prota, E. Mola, P. Negro, E. Cosenza, P. Zaffaroni

EXPERIMENTAL TESTING: GFRP strengthening (confinement of pillars, shear strengthening to prevent brittle failure mechanisms and confinement of external joints) of a full-scale reinforced concrete structure with three storeys above ground level, a regular elevation and a double asymmetrical plan section. Designed for gravitational loads only to represent the current building stock in southern Europe. Strengthened with **MAPEWRAP G UNI-AX** and **MAPEWRAP G QUADRI-AX**.

RESULTS: Testing demonstrated that, after being damaged, in the structure repaired and strengthened with GFRP:

- there was an increase in its overall ductility of 123%;
- there was a 50% increase in seismic stresses with no structural damage;
- there was no change in the mass of the structure and, therefore, no increase in seismic demand;
- the GFRP strengthening intervention was reversible.

REFERENCES:

M. Di Ludovico; E. Mola; G. Manfredi; P. Negro; A. Balsamo (2007). *Seismic strengthening of a full-scale RC structure - PART I: An analysis of pseudo-dynamic experimental testing. XXII National ANIDIS Convention, Pisa, 10-14 June 2007*

M. Di Ludovico; A. Balsamo; A. Prota; G. Manfredi; E. Cosenza (2006).



Design of Seismic Strengthening of an Irregular RC Structure by Using FRP laminates or RC Jacketing. Proceedings of the 2nd International fib Congress, Naples, 5-8 June 2006

A. Balsamo; G. Manfredi; E. Mola; P. Negro; A. Prota (2005). *Seismic Rehabilitation of a Full-Scale RC Structure using GFRP Laminates. 7th International Symposium on FRP Reinforcement for Concrete Structures, Farmington Hills (MI), 7-10 November 2005*

M. Di Ludovico; A. Balsamo; A. Prota; G. Manfredi (2008). *Comparative Assessment of Seismic Rehabilitation Techniques on a Full-Scale 3-Storey RC Moment Frame Structure. STRUCTURAL ENGINEERING AND MECHANICS, 2-s2.0-41449089254*

A. Balsamo; M. Di Ludovico; G. Manfredi; A. Prota. *Seismic strengthening using FRP: SPEAR structure. REALTÀ MAPEI INTERNATIONAL*

Balsamo A.; Di Ludovico M.; Manfredi G.; Prota A. (2009). *A study of structural strengthening using the FRP System. COMPOSITI MAGAZINE*



MITRAS Project (Materials, Technologies and Innovative Design Methods for the Repair and Strengthening of Highway Infrastructures) *Strengthening of full-scale RC bridge beams with CFRP*

YEAR: 2008

LOCATION: “Outdoor” laboratory in Brindisi designed by the Federico II University of Naples - Faculty of Structural Engineering and Architecture

LEAD RESEARCHERS: M. Di Ludovico, A. Balsamo, A. Prota, G. Manfredi, E. Cosenza, P. Di Stasio

EXPERIMENTAL TESTING: Five full-scale prestressed reinforced concrete beams were prepared and validation tests were conducted using CFRP fabrics (**MAPEWRAP C UNI-AX**) to restore the flexural strength of prestressed reinforced concrete beams, and used in the construction of motorway bridges damaged by accidental impact loads (impacted by wide trucks), which caused a partial loss in strength due to shearing of some of the strands of the longitudinal reinforcement.

RESULTS: The use of CFRP strengthening enabled the rigidity and flexural strength to be restored (recovery of 13% and 17% of bending moment capacity in the beams with 17% and 33% of the strands sheared by the impact loads).

REFERENCES:

M. Di Ludovico; A. Balsamo; A. Prota; G. Manfredi (2009). *FRP strengthening of full scale PC girders*. 9th International Symposium on Fibre-Reinforced Polymer Reinforcement for Concrete Structures, Sydney (Australia), 13-15 July 2009

M. Di Ludovico; A. Balsamo; A. Prota; G. Manfredi; E. Cosenza (2008). *Strengthening of full-scale prestressed concrete bridge beams using FRP*. XVII CTE Congress, Rome, 5-8 November 2008





TE.M.P.E.S. Project (Technologies and Innovative Materials for Seismic Protection of Historic Buildings)

Testing on a shaking table of 1:2 scale tuff rubble masonry buildings consolidated with GFRP

YEAR: 2005-2006

LOCATION: CESI Laboratory, Seriate (Bergamo)

LEAD RESEARCHERS: G. Bergamo, A. Balsamo, A. Prota, I. Langone, G. Manfredi

EXPERIMENTAL TESTING: As part of a test campaign, two 1:2 scale models (in length) of tuff rubble masonry buildings were built and subjected to testing on a shaking table using real accelerograms recorded in Italy (Calitri in 1980 and Colfiorito in 1997). The models without strengthening were consolidated after they had been damaged by applying reversible, innovative strengthening techniques based on the use of glass fibre composite materials (GFRP).

RESULTS: The two models, with and without strengthening, demonstrated a rocking-type collapse mechanism with the formation of horizontal cracks at the interface between the coupling beam and the wall bay. The dynamic tests carried out on the strengthened models highlighted an increase in lateral rigidity, which confirms the effectiveness of the strengthening techniques adopted in contrasting the mechanism that had been activated. The strengthening technique of applying strips of GFRP proved to be sufficient for repair work following "aftershocks". The accelerated ageing tests conducted in a Weatherometer allowed any deterioration phenomena of the epoxy matrix caused by exposure to freeze/thaw cycles to be eliminated.



REFERENCES:

Langone, A. Prota, G. Bergamo, G. Manfredi. *Experimental analysis with a vibrating table of two tuff masonry models consolidated with composite materials. XII Anidis Convention, 10-14 June 2007, Pisa*



MAPEI S.p.A. ICC-ES CERTIFICATION OF MAPEWRAP FRP SYSTEM

Scale models of reinforced concrete columns confined with CFRP

YEAR: 2014

LOCATION: Federico II University of Naples - Faculty of Structural Engineering and Architecture

LEAD RESEARCHERS: A. Balsamo, A. Prota, A. Nanni, F. De Caso y Basalo, D. Pisapia, P. Campanella

EXPERIMENTAL TESTING: A series of tests were conducted on scale models of 800 mm high square, reinforced concrete columns with sides measuring 200 mm. Axial compression tests were conducted on four columns: two “as-built” control columns and two strengthened by being confined with a continuous strip of CFRP (**MAPEWRAP C UNI-AX**) for their entire height. Two classes of concrete (low-strength and high-strength) and two different amounts of CFRP **MAPEWRAP C UNI-AX** (low level of strengthening and high level of strengthening) were taken into consideration.

RESULTS: The tests were conducted as part of the application for ICC-ES AC 125 certification and validated the design criteria contemplated by codes ACI 318 and ACI 440 and the acceptance of CFRP material according to AC 125 standards. Application of a CFRP strengthening system (**MAPEWRAP C UNI-AX**) increased the compressive strength and axial displacement capacity (pseudo-ductility) of the structural elements without affecting their initial rigidity.

REFERENCES:

CERTIFIED TEST REPORT EVALUATION OF EXTERNALLY APPLIED FRP STRENGTHENING COMPOSITE SYSTEMS - Per ICC-ES Acceptance Criteria AC125 -ESR-3499 Report Number: R-5.10.12-12-02_MAP.3 Date: July 28, 2016 REVISION 3

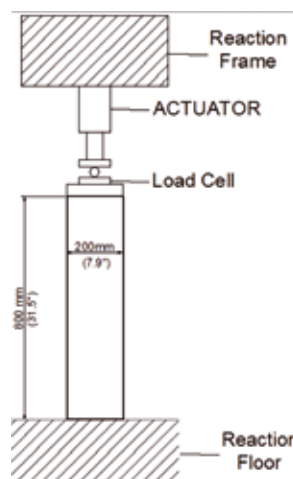



ReLUIS “SEISMIC ENGINEERING UNIVERSITY LABORATORY NETWORK” Task 2.1.1: Reinforced Concrete Structures PE 2010-2013 *Strengthening of reinforced concrete joints with CFRP*

YEAR: 2010 - 2014

LOCATION: Federico II University of Naples - Faculty of Structural Engineering and Architecture

LEAD RESEARCHERS: M. Di Ludovico, A. Balsamo, A. Prota, G. Manfredi, M. Dolce, C. Del Vecchio, G.M. Verderame

EXPERIMENTAL TESTING: Nine full-scale beam-pillar joints without confinement were created in order to reproduce models of existing reinforced concrete buildings designed according to gravitational loads only and with no reference to seismic loads, that is, according to obsolete reference standards, to evaluate the effect of seismic loads.

RESULTS: The results of the tests conducted on beam-pillar joints strengthened with CFRP demonstrated the following:

- an increase in the shear strength of the joint panel;
- effective confinement of the ends of the pillar portion of the joint;
- an increase in the shear strength of the beam portion of the joint;
- no variation in the rigidity of the joint.

REFERENCES:

Balsamo, A.; Del Vecchio C.; Di Ludovico, M.; Prota, A.; Manfredi G.; Dolce, M. (2012). *Strengthening of existing beam-pillar hinge-points with FRP: experimental analysis and capacity models. (in Italy)*. 19th CTE Congress, Bologna

Del Vecchio C, Di Ludovico M, Balsamo A, Prota A, Manfredi G, Dolce M. 2014. *Experimental Investigation of Exterior RC Beam-Column Joints Retrofitted with FRP Systems. ASCE Journal of Composites for Construction. V 18 (4). pages 1-13. DOI: 10.1061/(ASCE)CC.1943-5614.0000459*



Di Ludovico M.; Balsamo A.; Prota A.; Verderame G.M.; Dolce M.; G. Manfredi (2012). *Preliminary Results of an Experimental Investigation on RC beam-column joints. Proceedings of 6th International Conference on FRP Composites in Civil Engineering, Rome, 13 -15 June 2012*

ReLUIS “SEISMIC ENGINEERING - UNIVERSITY LABORATORY NETWORK”

Task 2.1.1: Reinforced Concrete Structures PE 2010-2013

Shear and flexural strengthening of pillars with CFRP



YEAR: 2015-2017

LOCATION: Federico II University of Naples - Faculty of Structural Engineering and Architecture

LEAD RESEARCHERS: M. Di Ludovico, A. Balsamo, A. Prota, G. Manfredi, M. Del Zoppo

EXPERIMENTAL TESTING: Testing was conducted on two sets of pillars: three slender columns (1500 mm high) with flexural behaviour and five stocky columns (900 mm high) with brittle behaviour characterised by shear failure before reaching their flexural capacity. The pillars were designed to represent elements typically found in existing buildings in Italy. The slimmer pillars, characterised by flexural failure, were strengthened with strips of CFRP around the potential plastic hinge point. The pillars characterised by shear failure, on the other hand, were strengthened with discontinuous strips of CFRP for the entire height of the element. Different classes of concrete and amounts of CFRP were investigated. The seismic behaviour of the pillars was evaluated through cyclical testing with controlled displacement by applying an adimensional load equal to 0.1 at right angles to the pillars, a condition typically found in existing buildings.

RESULTS: The results of the tests demonstrated that after applying CFRP:

- there was an increase in ductility of the pillars confined at the base;
- there was an increase in shear strength of the stocky pillars strengthened with CFRP;
- the failure mode of the stocky pillars strengthened with CFRP changed from brittle to ductile;
- there was no change in the rigidity of the pillars.

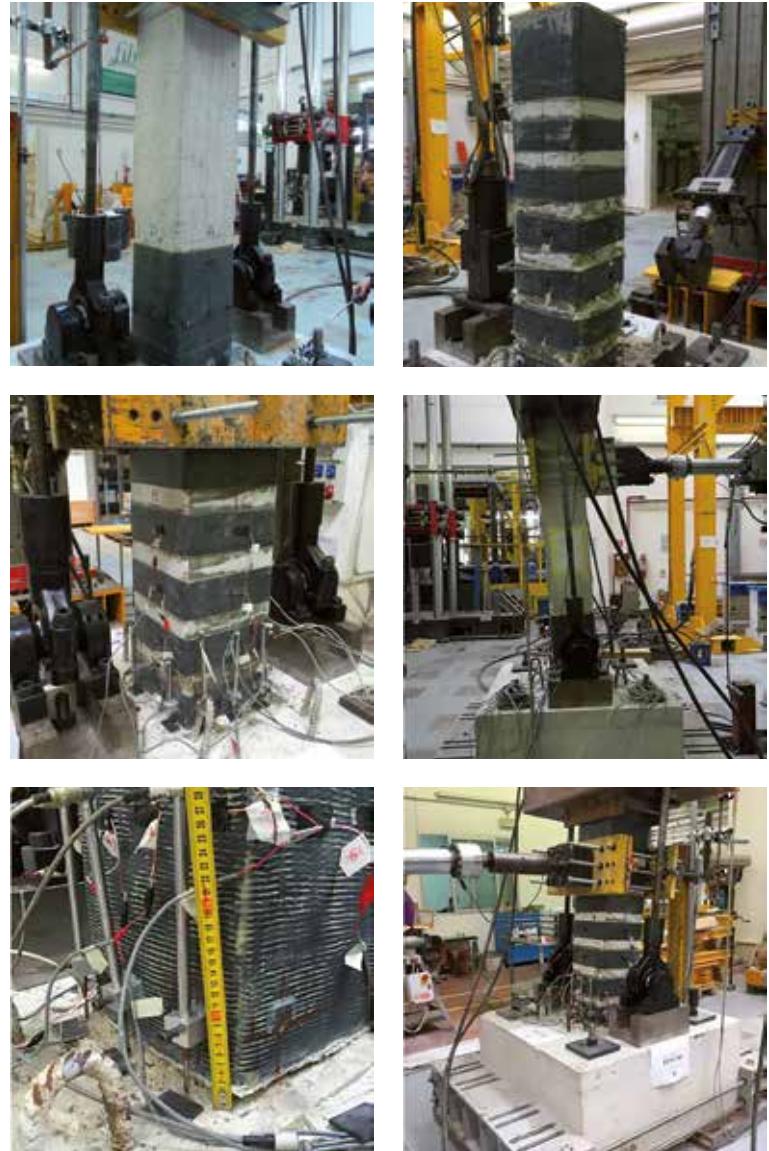

REFERENCES:

Del Zoppo, M., Di Ludovico, M., Balsamo, A., Prota, A., Manfredi, G. (2017). FRP for seismic strengthening of shear controlled RC columns: experience from earthquakes and experimental analysis. *Composite Part B*, 10.1016/j.compositesb.2017.07.028

Del Zoppo, M.; Di Ludovico, M.; Balsamo, A.; Prota, A. Comparative Analysis of Existing RC Columns Jacketed with CFRP or FRCC. *Polymers* 2018, 10, 361



ReLUIS (Research line No. 8); MACE Project (Innovative Composite Materials for the Building Industry)

Compressive loads on full-scale and scale-model masonry columns strengthened with FRP systems

YEAR: 2008-2013

LOCATION: Federico II University of Naples - Faculty of Structural Engineering and Architecture

LEAD RESEARCHERS: A. Prota, M. Di Ludovico, A. Balsamo, E. Fusco, G. Maddaloni, C. D'Ambra, F. Micelli, G. Manfredi

EXPERIMENTAL TESTING: Axial compression tests on full-scale and scale-model samples made from different types of masonry (tuff, bricks and limestone) demonstrated the effectiveness of continuous and discontinuous FRP confinement using different types of fibres (carbon, glass and basalt) impregnated with epoxy resin.

RESULTS: The various FRP confinement techniques gave the columns a higher level of strength and ductility and exhibited a marked dissipative behaviour compared to the brittle behaviour of similar samples without strengthening.

REFERENCES:

Di Ludovico M., D'Ambra C., Prota A., Manfredi G., (2010), "FRP Confinement of Tuff and Clay Brick Columns: Experimental Study and Assessment of Analytical Models", *ASCE - Journal of Composites for Construction*, Vol. 14, No. 5, pages 583-596, Sept-Oct. 2010 (ISSN: 1090-0268)

Micelli F., Di Ludovico M., Balsamo A., and Manfredi G., (2014) "Mechanical behaviour of FRP-confined masonry by testing of full-scale columns". *Special Issue "S.I.: Advances in composites applied to masonry" SPRINGER Materials and Structures*, Volume 47, Issue 12, October 21 2014, pages 2081-2100, DOI: 10.1617/s11527-014-0357-9

Di Ludovico, M., Fusco, E., Prota, A., & Manfredi, G. (2008, October). *Experimental behaviour of masonry columns confined using advanced materials*. In *The 14th world conference on earthquake engineering*



1.2

FRG SYSTEM

1.2.1

DEFINITION

Unlike FRP, the various systems that form the macro-family of FRG (*Fibre Reinforced Grout*) are made up of an inorganic matrix (mortar) in which strengthening fibres in the form of mesh are embedded.

The aim of this type of technology is to improve the mechanical properties of masonry and increase the level of collaboration between the various elements constituting the masonry (typically bricks and mortar).

The traditional strengthening technique consists of the application of reinforced render made from electro-welded mesh embedded in several centimetres of concrete. However, even though this technique increases the strength of masonry, it can also create other types of problems caused by a considerable increase in rigidity due to the high modulus of elasticity of concrete (which is usually cementitious and, therefore, not very compatible with the substrate) and the electro-welded reinforcing mesh applied,

which often has problems generated by the onset of corrosion and, above all, can be difficult to apply, particularly on uneven or irregular substrates.

With these problems in mind, MAPEI has developed what are known as FRG systems which replace the metal mesh with A.R. glass fibre, carbon fibre or basalt fibre mesh. Traditional cementitious concrete, on the other hand, is replaced by fibre-reinforced, ductile mortar which is mechanically and chemically compatible with the masonry.

FRG systems may be divided into the following families: **FRCM** (*Fibre Reinforced Cementitious Matrix*) and **CRM** (*Composite Reinforced Mortar*) systems, that is, reinforced render with glass fibre meshes.

1.2.2

TYPES OF MATERIAL AND AREAS OF USE

CRM SYSTEM

CRM systems are made up of mortars suitable for application in layers up to 3-4 cm thick, so they also cover the surface of uneven masonry, combined with A.R. glass fibre mesh. Because of the thickness applied, the system needs to be connected mechanically to the masonry with glass fibre connectors.



Application of a strengthening package to increase shear-tensile and compressive strength

MORTAR	MAPEWALL RENDER & STRENGTHEN		MAPE-ANTIQUÉ STRUTTURALE NHL	
Chemical nature	Fibre-reinforced, breathable rendering and masonry mortar made from natural hydraulic lime		Cement-free, breathable rendering and masonry mortar made from natural hydraulic lime and Eco-Pozzolan	
Thickness applied (per layer)	10 to 30 mm		10 to 40 mm	
Compressive modulus of elasticity	10 GPa		10 GPa	

MESH	MAPENET EM 30	MAPENET EM 40	CONNECTORS	MAPENET EM CONNECTOR
Chemical nature	A.R. glass fibre	A.R. glass fibre	Chemical nature	Alkali-resistant glass fibre
Mesh size	30 x 30 mm	40 x 40 mm	Connector size	100 x 200; 100 x 500; 100 x 700 (mm)



While waiting for the National Guidelines regarding the design of CRM packages to be released, dimensions for this type of strengthening package make reference to those for reinforced render using the relative tables contained in NTC Memorandum 2018.



Qualification of systems according to Guidelines for the identification, qualification and acceptance criteria of preformed mesh systems in fibre-reinforced composite materials with a polymer matrix used for the structural consolidation of existing constructions with the reinforced render technique CRM (Composite Reinforced Mortar) or with the corresponding ETA.



FRCM SYSTEM

FRCM systems are made up of special fibre-reinforced mortars applied in low thickness layers (around 1-1.5 cm) in combination with various types of strengthening mesh (made from glass, basalt or carbon fibre). These systems allow the mass and rigidity of the strengthening package to be reduced effectively while significantly increasing its mechanical properties. The mortar used in such systems adheres very strongly to the substrate so that there is no need for transversal connectors. If a mechanical connector is absolutely necessary, specific **MAPEWRAP FIOCCO** anchoring ties may be used (bows made from glass fibre, basalt fibre or carbon fibre).

MORTAR	PLANITOP HDM MAXI	PLANITOP HDM RESTAURO
		
Chemical nature	Two-component, fibre-reinforced, high-ductility cementitious mortar made from Pozzolan-reaction binders.	Two-component, cement-free, fibre-reinforced mortar made from natural hydraulic lime (NHL) and Eco-Pozzolan.
Thickness applied (per layer)	6 to 25 mm	3 to 10 mm
Compressive modulus of elasticity	10 GPa	8 GPa

MESH	MAPEGRID G 220	MAPEGRID B 250
		
Chemical nature	A.R. glass fibre	Basalt fibre
Mesh size	21 x 21 mm	6 x 6 mm



Application of a compact strengthening system to increase the shear-tensile strength of bay walls



Extra mechanical connection with carbon fibre bows





















Application of an FRCM system to prevent collapse of dividing and buffer walls





















Strengthening package for the extrados of a masonry vault

*Design is possible through CNR-DT 215/2018 or by referencing chapter 11 of NTC 2018, with international standards such as ACI 549-4R-13 (MAPEI STRUCTURAL DESIGN).
Qualification of systems according to Guidelines for the identification, qualification and acceptance criteria of fibre-reinforced composites with an inorganic matrix (FRCM) used for the structural consolidation of existing constructions or with the corresponding ETA.*



		Thickness applied	Increase in rigidity	Increase in mass	Practicality of system	Mechanical connectors
TRADITIONAL RENDER REINFORCED WITH STEEL MESH		 <p>At least 5 cm</p>	 <p>Increasing the thickness of the masonry and the use of stiff steel mesh increase the overall rigidity of the structure</p>	 <p>Increasing the thickness of the masonry increases the overall mass of the structure (the load-bearing capacity of the foundations needs to be increased)</p>	 <p>Mechanical connectors required</p> <p>Handling on site is more difficult</p>	 <p>Holes for the connectors need to be drilled and cleaned</p>
RENDER REINFORCED WITH GLASS FIBRE MESH (CRM SYSTEM)		 <p>3 to 5 cm</p>	 <p>Increasing the thickness of the masonry increases the overall rigidity of the structure</p>	 <p>Increasing the thickness of the masonry increases the overall mass of the structure (the load-bearing capacity of the foundations needs to be increased)</p>	 <p>Handling on site and application of glass fibre mesh is easier than with metal mesh.</p> <p>Mechanical connectors required</p>	 <p>Holes for the connectors need to be drilled and cleaned</p>
FRCM SYSTEM		 <p>1 to 2 cm</p>	 <p>The increase in the thickness of the masonry is limited which means there is only a slight increase in the overall rigidity of the structure.</p>	 <p>The increase in the thickness of the masonry is limited which means there is only a slight increase in the overall mass of the structure.</p>	 <p>Handling on site and application of glass fibre mesh is easier than with metal mesh.</p> <p>The use of mechanical connectors may be avoided; it is usually sufficient to roughen the surface of the substrate</p>	 <p>The two-component mortar adheres very strongly to the substrate which means the use of mechanical connectors may be avoided or limited</p>

Speed of installation	Increase in shear strength	Increase in compressive strength	Increase in ductility	Compatibility with the substrate	Durability
 Traditional stiff metal mesh is difficult to cut and place (particularly on vaults)		 Increase in the area subjected to compressive loads due to an increase in thickness		 Use of mortar and mesh with too high modulus of elasticity	 Use of mesh with no chemical resistance
 Glass fibre mesh is easy to cut and place Mortar may also be applied by spray		 Increase in the area subjected to compressive loads due to an increase in thickness		 Use of mortar and mesh with low modulus of elasticity compatible with the substrate	 A.R. glass fibre mesh is resistant to the alkaline nature of the mortar (always request the relative certificate)
 Glass and basalt fibre mesh is easy to cut and place Mortar may also be applied by spray		 Lower increase in the area subjected to compressive loads	 High increase in strength and plastic deformation before failure (request test report)	 Use of mortar and mesh with low modulus of elasticity compatible with the substrate	 A.R. glass fibre and basalt mesh is resistant to the alkaline nature of the mortar (always request the relative certificate)

 Sufficient
  Moderate
  Good
  Excellent

1.2.3 EXPERIMENTAL TESTING

MAPEI S.p.A.; ReLUIS project - DPC 2010–2013 (LINE AT1-1.1) Evaluation and reduction of the vulnerability of masonry buildings)

Diagonal compression tests on various types of masonry panel strengthened with FRGM/CRM

YEAR: 2004 - 2018 (ongoing)

LOCATION: Federico II University of Naples - Faculty of Structural Engineering and Architecture

LEAD RESEARCHERS: A. Balsamo, I. Iovinella, G. Maddaloni, P. Di Stasio, F. Parisi, N. Augenti, M. Di Ludovico, G.P. Lignola, A. Prota, G. Manfredi, G. Morandini

EXPERIMENTAL TESTING: A campaign of diagonal compression tests was conducted on a very large number of samples made up of numerous different types of masonry (Neapolitan tuff, red bricks, rough-cut blocks, irregular stone, etc.) laid in various patterns and with a large number of different strengthening packages and transversal connectors (tie-rods).

RESULTS: The aim of the test campaign was to study the interaction between the various types of masonry and the various **MAPEI FRG (FRGM/CRM)** strengthening packages. Not only do the results demonstrate that the strengthening systems comply with the relative standards, they also show:

- there is an increase in shear/tensile capacity;
- there is a delay in cracking being triggered;
- there is a high increase in ductility;

REFERENCES:

Balsamo A., Iovinella I., Morandini G., Maddaloni G., (2014). *Experimental Investigation on IMG masonry reinforcement*, 37th IABSE – International Association for Bridge and Structural Engineering, Madrid, Spain, September 2014



Balsamo, A.; Iovinella, I.; Di Ludovico, M.; Prota, A. (2014). *Masonry reinforcement with IMG Composites: Experimental Investigation*. 4th International Conference on Mechanics of Masonry Structures Strengthened with Composite Materials, Ravenna, 9-11 September 2014

Balsamo Alberto, Iovinella Ivano (2014). *FRG strengthening systems for masonry structures*. REHABEND 2014, 1-4 April, 2014, Santander, Spain

Balsamo A., Iovinella I., Morandini G. (2014). *FRG Strengthening Systems for Masonry Buildings*, 2014 NZSEE Conference, Auckland
F. Parisi; I. Iovinella; A. Balsamo; N. Augenti; A. Prota (2012). *In-plane behaviour of tuff masonry strengthened with inorganic matrix-grid composites in diagonal compression*. Proceedings of the 15th

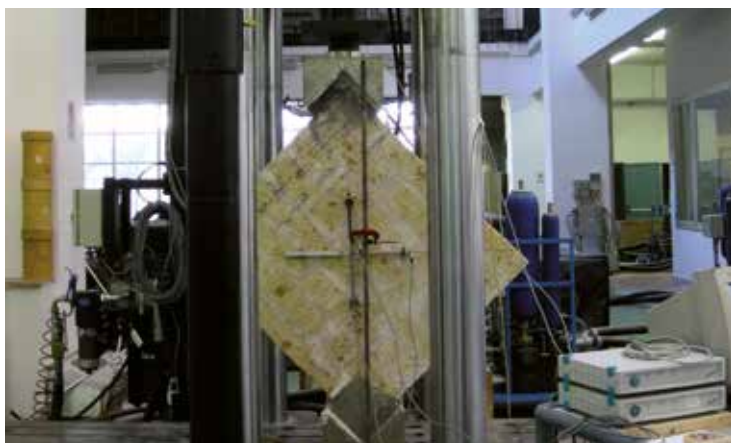

.....
European Conference Composite Materials, Venice, 24-28 June 2012
Parisi F.; Iovinella I.; Balsamo A.; Augenti N.; Prota A. (2011). Experimental investigation on the shear strength of tuff masonry strengthened with composite materials with an inorganic matrix. XIV ANIDIS Convention, Bari, 18-22 September 2011

Balsamo Alberto, Iovinella Ivano, Morandini Giulio (2011). Experimental Campaign on Tuff Masonry Strengthened with FRG. SEWC 2011 - Structural Engineering World Congress, Como, 4-6 June 2011

Balsamo, A.; Di Ludovico, M.; Prota, A.; Manfredi, G. (2011). Masonry Walls Strengthened with Innovative Composites. Proceedings of the FRPRCS-10 - 10th International Symposium on Fibre-Reinforced Polymer Reinforcement for Concrete Structures, Farmington Hills

.....
(MI), 2-4 April 2011

Balsamo A.; Iovinella I.; Morandini G.; Prota A. (2010). Experimental behaviour of tuff masonry strengthened with eco-Pozzolan based FRP. COMPOSITI MAGAZINE

Balsamo A.; Iovinella I.; Di Ludovico M.; Prota A. (2010). Experimental Behaviour of Tuff Masonry Strengthened with Lime Matrix - Grid Composites. Proceedings of the 3rd International Workshop on Conservation of Heritage Structures Using FRM and SHM, Ottawa (Canada), 11-13 August 2010

Balsamo A.; Prota A.; Iovinella I.; Morandini G. (2010). Experimental behaviour of tuff masonry strengthened with eco-Pozzolan based FRG. Safety and Conservation of Cultural Assets hit by Seismic Activity, Venice, 8-9 April 2010



PROVACI project (Technology for the Seismic Protection and Promotion of Complexes of Cultural Interest) STRESS DISTRICT

Test campaign on full-scale vaulted elements strengthened with FRCM

YEAR: 2013

LOCATION: Federico II University of Naples - Faculty of Structural Engineering and Architecture

LEAD RESEARCHERS: A. Balsamo, G.P. Lignola, G. Manfredi, A. Prota, I. Iovinella, G. Maddaloni, V. Giamundo, G. Ramaglia, M. Pallecchia, A. Zinno, F. da Porto

EXPERIMENTAL TESTING: The vaulted element tested on a shaking table simulated the typical geometry of roofs on churches and historic buildings. The aim of the test was to study the dynamic behaviour of just the masonry vault under the effect of severe seismic loads and the improvement in its performance properties after being strengthened with FRCM systems.

RESULTS: A real accelerogram (Irpinia 1980) and an artificial accelerogram created specifically for this test were applied incrementally. The results showed there was an increase in strength enabling the vault to resist loads with an intensity of more than 2.5 times the initial PGA. The mechanical compatibility of the strengthening system being tested showed no delamination phenomenon between the mortar/brick and mortar/strengthening interfaces. Also, the strengthening system did not significantly increase the mass of the sample compared to the original one.

REFERENCES:

V. Giamundo; G.P. Lignola; G. Maddaloni; A. Balsamo; A. Prota; G. Manfredi (2015). *Experimental investigation of the seismic performances of IMG reinforcement on curved masonry elements. COMPOSITES PART B, ENGINEERING*, 10.1016/j.compositesb.2014.10.039

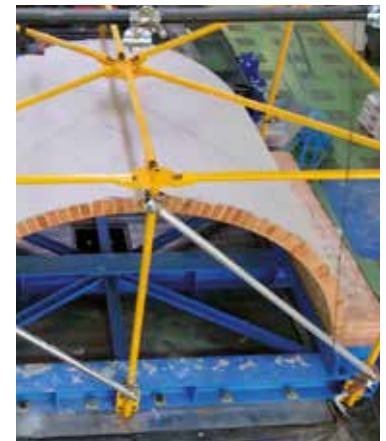

V. Giamundo, G.P. Lignola, G. Maddaloni, F. da Porto, A. Prota and G. Manfredi. *Shaking table tests on a full-scale unreinforced and IMG-retrofitted clay brick masonry barrel vault. SPRINGER Bulletin of Earthquake Engineering*, Volume 14 No. 6, 2016:1663-1693 DOI: 10.1007/s10518-016-9886-7

V. Giamundo; G. Ramaglia; A. Balsamo; G.P. Lignola; A. Prota; G. Manfredi; G. Maddaloni; A. Zinno. *Strengthening of a masonry vault: evaluation of its effectiveness through vibrating table tests. XVI Anidis Convention 2015, L'Aquila, Italy, September 2015*

A. Prota, M. Pallecchia, G.P. Lignola, A. Zinno, A. Balsamo, I. Iovinella, G. Maddaloni. *Experimental evaluation through vibrating table tests of the effectiveness of strengthening work on masonry vaults with FRG systems. INGENIO Magazine dossier #31 "Structural strengthening and consolidation systems", Vol.31, April 2015:1-24. ISSN 2307-8928*



PROVACI project (Technology for the Seismic Protection and Promotion of Complexes of Cultural Interest) STRESS DISTRICT

Test campaign on full-scale vaulted elements and piers strengthened with FRCM

YEAR: 2014-2015

LOCATION: Federico II University of Naples - Faculty of Structural Engineering and Architecture

LEAD RESEARCHERS: A. Balsamo, G.P. Lignola, G. Manfredi, A. Prota, G. Ramaglia, I. Iovinella

EXPERIMENTAL TESTING: The aim of the test campaign with a shaking table was to study the dynamic behaviour of masonry vaults with a typical geometry and on their interaction with the walls below the vault in order to protect the vaulted portion from being damaged by applying FRCM systems with basalt mesh and steel fabric.

RESULTS: Two real accelerograms (Friuli 1976 and Irpinia 1980) were applied incrementally to simulate numerous seismic events of increasing intensity and responses (earthquake swarm) acting on the masonry structure. The vaulted portion of the structure without strengthening collapsed. After rebuilding the structure and applying an FRCM strengthening package combined with traditional backfilling, there was no damage to the structure in the vaulted portion, even when twice the intensity in PGA was applied compared to the event that provoked the collapse of the structure.

REFERENCES:

Giancarlo Ramaglia; Gian Piero Lignola; Alberto Balsamo; Andrea Prota, 2017. *Seismic Strengthening of Masonry Vaults with Abutments Using Textile-Reinforced Mortar*. DOI: 10.1061/(ASCE)CC.1943-5614.0000733. © 2016 American Society of Civil Engineers





ReLUIS project - DPC 2010–2013 (LINE T1–1.1 Evaluation and reduction of the vulnerability of masonry buildings)

Test campaign on full-scale hollow-brick masonry strengthened with FRCM

YEAR: 2010

LOCATION: Federico II University of Naples - Faculty of Structural Engineering and Architecture

LEAD RESEARCHERS: N. Augenti, F. Parisi, A. Balsamo, A. Prota, G. Manfredi, I. Iovinella

EXPERIMENTAL TESTING: Tests were conducted on a full-scale, tuff hollow-brick wall designed to concentrate most of the damage in the coupling panel, the type of instability that often occurs in existing masonry buildings.

RESULTS: Not only did the external FRCM strengthening system applied to the coupling beam enable its horizontal load-bearing capacity to be fully restored, it also helped increase its displacement capacity quite considerably by “shifting” its loss in resistance to large amounts of lateral movement. The FRCM system also provided a further dissipation means by spreading the damage throughout the entire coupling panel, rather than diagonally due to the effect of shear failure and the pattern of the masonry elements.

REFERENCES:

N. Augenti; F. Parisi; A. Prota and G. Manfredi. *In-Plane Lateral Response of a Full-Scale Masonry Subassembly with and without an Inorganic Matrix-Grid Strengthening System*. *Journal of Composites for Construction*, Vol. 15, No. 4, August 1, 2011. ©ASCE, ISSN 1090-0268/2011/4-578-590

Parisi F.; Augenti N.; Balsamo A.; Prota A.; Manfredi G.(2010). *Lateral Loading Tests on a Masonry System With and Without External Reinforcement*. 14th European Conference on Earthquake Engineering, Ohrid (FYRoM), 30 August - 3 September 2010



ReLUIS (Research Line No. 8); MACE Project (Innovative Composites for the Building Industry); METRICS Project (Methods and Technologies for the Management and Redevelopment of Old Town Centres and Listed Buildings) STRESS DISTRICT



Compression tests on full-scale and scale-size masonry columns, in various types of material, strengthened with FRCM

YEAR: 2008-2013-2017

LOCATION: Federico II University of Naples - Faculty of Structural Engineering and Architecture

LEAD RESEARCHERS: A. Balsamo, M. Di Ludovico, A. Prota, E. Fusco, G. Maddaloni, C. D'Ambra, F. Micelli, A. Cascardi, M.A. Aiello, G. Manfredi, I. Iovinella

EXPERIMENTAL TESTING: The test campaign investigated the effectiveness of passive confinement techniques by applying FRCM systems on full-scale and scale-model tuff, brick, stone and limestone masonry columns. The samples tested under centred compressive loading were strengthened with glass fibre (**MAPEGRID G 220**) or basalt (**MAPEGRID B 250**) mesh embedded in an inorganic matrix (**PLANITOP HDM RESTAURO**), both with and without tie-rods.

RESULTS: The various FRCM confinement techniques adopted gave the columns a higher level of strength and ductility and exhibited a marked dissipative behaviour compared with the brittle behaviour of similar samples without strengthening.

REFERENCES:

A. Balsamo; G. Maddaloni; F. Micelli; A. Prota; G. Melcangi (2018). "Experimental behaviour of full scale masonry columns confined with FRP or FRCM systems", *REHABEND 2018 Euro-American Congress on Construction Pathology, Rehabilitation Technology and Heritage Management, Caceres, Spain, May 2018*

G. Maddaloni, A. Cascardi, A. Balsamo, M. Di Ludovico, F. Micelli, M.A. Aiello, A. Prota (2017). "Confinement of Full-Scale Masonry Columns



with FRCM Systems", *MURICO 5 CONFERENCE – Mechanics Of Masonry Structures Strengthened With Composite Materials - Key Engineering Materials* ISSN: 1662-9795, Vol. 747, pages 374-381

Di Ludovico, M., Fusco, E., Prota, A., & Manfredi, G. (2008). Experimental behaviour of masonry columns confined using advanced materials. In *The 14th world conference on earthquake engineering*



METRICS project (Methods and technologies for the management and redevelopment of old town centres and listed buildings): STRESS DISTRICT

Experimental testing on a shaking table of a 1:2 scale model of a masonry building strengthened with FRCM

YEAR: 2016

LOCATION: Federico II University of Naples - Faculty of Structural Engineering and Architecture

LEAD RESEARCHERS: M. Di Ludovico, A. Balsamo, G. Maddaloni, N. Iuliano, G. Maddaloni, A. Prota, G. Manfredi

EXPERIMENTAL TESTING: Within the framework of the Metrics research project, a study was conducted on the seismic behaviour of 1:2 scale models of single-wall tuff masonry structure with timber joist floor to reproduce a typical building of the Naples area, which was repaired and strengthened after being damaged with innovative FRCM systems.

RESULTS: The structure was tested on a shaking table and underwent a series of simulated seismic sequences with accelerograms of recent earthquakes in Italy, including L'Aquila in 2009 and Amatrice in 2016. The failure mechanisms and damage typical of encased masonry structural elements were studied. After being damaged, the structure was repaired using traditional technology and by:

- injecting the cracks with cement-free, highly plastic mortar made from lime and eco-Pozzolan (**MAPE-ANTIQUE F21**);
- restraining the cornerstones and stitching the sub-horizontal cracks with dry-applied stainless steel bars (**MAPEI STEEL DRY 316**).

The structure was strengthened by applying the following innovative packages:

- stitching the diagonal cracks with an FRCM system (**MAPEGRID G 220 + PLANITOP HDM RESTAURO**);
- binding the ends with an FRCM system (**MAPEGRID G 220 + PLANITOP HDM RESTAURO**);

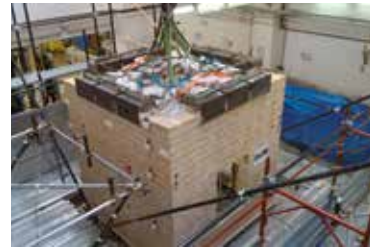

- interior and exterior render of the latest generation made from fibre-reinforced lime mortar (**PLANITOP INTONACO ARMATO**).

After being repaired and strengthened the structure showed no sign of damage, not even in the case of PGA of a significantly superior intensity (+40%) compared to the seismic sequence that caused the original damage.

REFERENCES:

Gennaro Maddaloni, M. Di Ludovico, A. Balsamo, Giuseppe Maddaloni, A. Prota (2018). "Dynamic assessment of innovative retrofit techniques for masonry buildings", *Composites Part B* 147 (2018) 147-161, <https://doi.org/10.1016/j.compositesb.2018.04.038>

Marco Di Ludovico, Alberto Balsamo, Gennaro Maddaloni, Nunzia Iuliano, Giuseppe Maddaloni, Andrea Prota, Gaetano Manfredi (2017). "Shaking Table Tests on 1/2 Scale One Story Masonry Structure", *7AESE - 7th International Conference on Advances in Experimental Structural Engineering, Pavia, September 2017*

1.3 HPC SYSTEM

HIGH-PERFORMANCE
FIBRE-REINFORCED
CEMENTITIOUS
MORTAR (FRC)

1.3.1

DEFINITION

Amongst the various technologies available to strengthen existing structures, MAPEI proposes a new family of mortars from the PLANITOP HPC line: cementitious mortars reinforced with structural steel fibres with very high mechanical properties dispersed evenly throughout the cementitious matrix.



Fibres dispersed
in a cementitious matrix

These materials are classed as HPFRCC (*High Performance Fibre-Reinforced Cementitious Composites*) and differ from traditional mortar for their very high mechanical strength and high level of ductility.

There are now various types of fibre available that may be used within a cementitious matrix, the most widely used being polymeric, metallic, glass, carbon or in natural material (cellulose, wood, etc.).

Unlike traditional synthetic fibres normally used in cementitious mortar (mainly to

reduce the onset of cracking), adding steel fibres (**FIBRE HPC**) increases the **ductility** and **toughness** of the mortar, makes it stronger during the plastic phase (post-cracking) and gives it a **work-hardening** type of **tensile behaviour**.

This means that the presence of these metallic fibres gives the material certain characteristics that allow the amount of traditional reinforcement to be reduced or, in many cases, to be completely replaced.

PLANITOP HPC and **PLANITOP HPC FLOOR** mortars are characterised by a cementitious matrix with very high mechanical properties, comparable with repair mortars for concrete in the following table:

	TRADITIONAL CONCRETE	CEMENTITIOUS MORTAR	PLANITOP HPC
Compressive strength	15 - 40 MPa	15 - 60 MPa	130 MPa
Tensile strength	-	-	8,5 MPa
Flexural strength	-	4 - 8 MPa	32 MPa

Graph representing residual flexural strength in compliance with EN 14651 standards

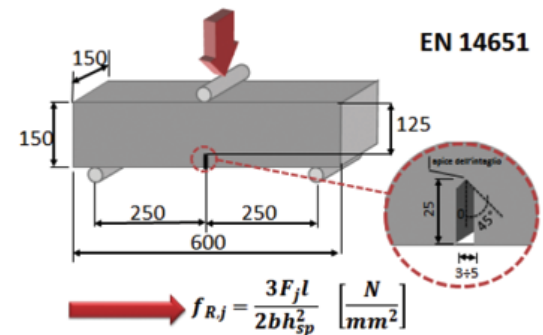
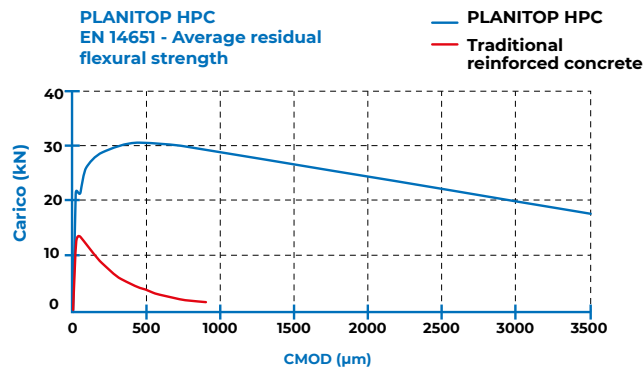

The design, execution and characterisation of structural elements that use PLANITOP HPC require different rules and calculation models than those normally adopted for elements made from standard cementitious conglomerate. These materials are not currently contemplated in Italian and European technical construction standards. To overcome this problem, a special commission of experts set up by CNR in 2006 issued a technical document (CNR DT 204/2006 – Instructions for the Design, Execution and Control of Fibre-reinforced Concrete Structures), which summarises the main properties of fibre-reinforced concrete and provides sufficient guidelines to correctly dimension and verify structures made from concrete reinforced with fibres instead of, or in addition to, standard steel reinforcement. The same instructions also provide all the indications required in order to verify the properties of fibre-reinforced cementitious materials in the laboratory and to determine the most significant values to carry out structural calculations.

For certification purposes, these types of product are considered to be in both the category covering structural mortars for repairing existing structures (with CE marking according to EN 1504-3:6) and the category covering FRC (Fiber Reinforced Concrete) with certification according to the guidelines from DPCSLLPP No. 208, 09/04/2019.



1.3.2

TYPES OF MATERIAL

AND AREAS OF USE

PLANITOP HPC FLOOR SYSTEM

One of the main areas of use for this particular technology is to strengthen existing floors with a compact structural screed made from **PLANITOP HPC FLOOR**, which may be applied to various types of floor, such as:

- wooden floors
- brick-concrete floors or reinforced concrete slabs
- steel floors.

PLANITOP HPC FLOOR



PLANITOP HPC FLOOR T



PLANITOP HPC FLOOR 46





Strengthening of the extrados of a brick-concrete floor



Strengthening of the extrados of a wooden floor



Strengthening of the extrados of a brick-concrete floor

The traditional method adopted to strengthen an existing floor is to add a structural screed at least 4-5 cm thick on the extrados made from cast concrete (traditional or lightweight concrete) reinforced with steel mesh.

Even though this strengthening system is widely adopted it has negative aspects, due mainly to the thickness of the layers that need to be added. These layers increase the mass and stiffness of the structure and are highly invasive from an operational and architectural point of view, and can create quite a few problems when redesigning internal spaces, the layout of plant systems and finishing packages.

The following table compares the traditional strengthening technique (structural screed reinforced with steel mesh) with the application of **PLANITOP HPC FLOOR** on a brick-concrete floor.



STRUCTURAL SCREED IN TRADITIONAL CONCRETE



LOW THICKNESS STRUCTURAL SCREED IN PLANITOP HPC FLOOR

Thickness applied	<p>At least 4-5 cm</p>	<p>1.5 to 3 cm</p>
Invasiveness	<p>Mechanical (dowels) or chemical (epoxy resin) connectors required</p>	<p>Roughening the surface of the substrate is sufficient</p>
Renovation work	<p>Very thick layers required; incompatible with existing internal spaces and measurements (such as windows)</p>	<p>Low thickness layer; compatible with existing internal spaces and measurements with room for underfloor heating and soundproofing systems</p>
Increase in rigidity		<p>Higher modulus of elasticity compensates for its low thickness</p>
Increase in mass	<p>Increase in inertia (seismic) caused by the increase in weight of the structure (due to the thickness of the layer applied); foundations need to be strengthened</p>	<p>Increase in weight is limited because the thickness is lower than systems with lightweight concrete</p>
Speed of installation	<p>Holes need to be drilled and cleaned, dowels have to be inserted and then attached to the steel reinforcement</p>	<p>NO connectors required (except in special circumstances), high mechanical properties after 24 hours, set to foot traffic within a few hours of application</p>
Increase in flexural strength		
Size of floor joists	<p>Floor joists are often too small to be able to use mechanical connectors and epoxy resin has to be used (such as EPORIP) for construction joints and for chemical anchors</p>	<p>This system does not require a minimum size for the floor joists</p>
Structural hyperstaticity		<p>Also suitable for hyperstatic structures (beams resting on several supports or corbel) thanks to the tensile strength of the material</p>

Sufficient
 Moderate
 Good
 Excellent

Unlike traditional techniques, not only do structural screeds made from **PLANITOP HPC FLOOR** or **PLANITOP HPC FLOOR T** allow the performance properties of floors to be improved, they have other important advantages:

- the low thickness layer applied (1.5-3 cm) limits the amount by which loads are increased and the distances between each floor are maintained;
- if the substrate is roughened sufficiently, the system adheres so strongly that the use of mechanical connectors and/or chemical anchors is limited or eliminated;
- no reinforcing mesh is required;
- high ductility and resistance to cyclical stresses and loads.

The compact weight of the strengthening system plays an important role, in that a lower permanent load on the structure means it can withstand heavier loads and accidental loads and, more importantly, it reduces the mass and induced seismic loads on the structure. The following table compares the average weight of various strengthening systems. Traditional screed with lightweight reinforcement and screed realised with **PLANITOP HPC FLOOR**.

	THICKNESS	DENSITY	OVERALL WEIGHT OF INTERVENTION	
Traditional concrete	5 cm	2400 kg/m ³	125 kg/m ²	-
Lightweight concrete	5 cm	1400 kg/m ³	75 kg/m ²	- 40 %
PLANITOP HPC FLOOR	2.5 cm	2400 kg/m ³	60 kg/m ²	- 52 %

BRICK-CONCRETE FLOOR

WOODEN FLOOR

STEEL-CONCRETE FLOOR

		
See strengthening for reinforced concrete buildings data sheet No. 8 A	See strengthening for masonry buildings data sheet No. 10 A	See strengthening for masonry and wooden buildings data sheet No. 10 B

PLANITOP HPC SYSTEM

By applying a strengthening package to pillars by cladding them with HPFRCC (*High Performance Fibre-Reinforced Cementitious Composites*), it is also possible to increase their load-bearing capacity (axial loads, bending moment and shear force). Confining concrete increases its displacement capacity and the ductility of the confined section.

PLANITOP HPC



PLANITOP HPC TIXO



The high fibre content of the product means much less or even no traditional reinforcement is required, as specified in the reference document CNR DT 204/2006; the thickness of the layer of **PLANITOP HPC** applied varies from 20 mm to 40 mm.





















Strengthening of a pillar with a compact jacking























Strengthening of a beam and pillar with a compact jacking



Strengthening of a sloping roof

		Thickness applied	Practicality of system	Increase in rigidity	Increase in mass	Speed of installation
TRADITIONAL INCREASE OF SECTION WITH REINFORCED CONCRETE		 <p>At least 5-10 cm</p>	 <p>Mechanical (dowels) or chemical (epoxy resin) connectors required</p>	 <p>Increase in stiffness of the structure due to high thickness of integrated section</p>	 <p>Increase in mass due to high thickness of integrated section (load-bearing capacity of foundations needs to be increased)</p>	 <p>Holes for the connectors need to be drilled and cleaned</p>
MORE COMPACT INCREASE OF SECTION WITH PLANITOP HPC		 <p>Typical thickness 1.5 to 3 cm</p>	 <p>Roughening the surface of the substrate is sufficient</p>	 <p>Limited increase in rigidity of the structure due to limited increase of section</p>	 <p>Limited increase in mass due to limited increase of section</p>	 <p>High mechanical properties after just 24 hours; formwork may be removed after 48 hours</p>
BINDING WITH FRP SYSTEM		 <p>Negligible</p>	 <p>Selected removal of secondary elements</p>	 <p>Negligible increase in rigidity due to negligible increase of section</p>	 <p>Negligible increase in mass due to negligible increase of section</p>	 <p>Application is immediate (wet on wet) for all the layers in the system</p>

Increase in shear strength of pillars or beams	Increase in flexural strength of pillars	Increase in compressive strength of pillars	Increase in strength at beam/pillar joints	Increase in flexural strength of beams	Increase in ductility	Resistance to fire
 <p>Added clamps increase strength significantly</p>	 <p>Significant increase but minimum amount of horizontal reinforcement required</p>	 <p>Significant increase but minimum amount of additional reinforcement required</p>	 <p>Very difficult and highly invasive installation</p>	 <p>Very difficult and highly invasive installation</p>		 <p>Concrete has high resistance to fire</p>
 <p>Added fibres increase strength significantly</p>	 <p>Significant increase while limiting or even avoiding integrating with traditional reinforcement</p>	 <p>Significant increase while limiting or even avoiding integrating with traditional reinforcement</p>		 <p>Moderately difficult and invasive, significant increase in rigidity of beams but limited increase in strength</p>		 <p>The presence of steel fibres does not alter the mortar's high resistance to fire</p>
 <p>Horizontal binding: significant increase in strength, especially pillars with little reinforcement</p>	 <p>Vertical and horizontal application: moderate increase in strength</p>		 <p>Easy to install</p>	 <p>Easy to install and not very invasive, significant increase in strength, especially beams with little reinforcement</p>		 <p>Protect with calcium silicate panels or specific fire-resistant mortar</p>



Sufficient



Moderate



Good



Excellent

1.3.3

EXPERIMENTAL TESTING



ReLUIS – DPC project “SEISMIC ENGINEERING - UNIVERSITY LABORATORY NETWORK” PE 2014-2018

Experimental testing on full-scale, reinforced concrete beam-pillar joints taken from buildings with earthquake damage

YEAR: 2016

LOCATION: Federico II University of Naples - Faculty of Structural Engineering and Architecture

LEAD RESEARCHERS: A. Balsamo, C. Del Vecchio, M. Di Ludovico, A. Prota, G. Manfredi

EXPERIMENTAL TESTING: The tests were conducted on two beam-pillar joints taken from a reinforced concrete building from the 1960's in L'Aquila that had been damaged by the earthquake that struck the city in 2009. The structural frame system was characterised by poor quality concrete and steel reinforcement typically found in buildings designed before the 1970's. The strengthening package was applied by firstly removing the outer layer of the concrete down to a depth of around 40 mm to expose the steel reinforcement running longitudinally around the edges of the beams and pillars. The concrete was then reintegrated by applying **PLANITOP HPC** and **FIBRE HPC**.

RESULTS: An analysis of the crack formation showed that reintegrating the concrete around the steel reinforcement with **PLANITOP HPC** transferred the failure mode, from a brittle failure in the hinge-point panel to the development of a plastic hinge at the beam-hinge interface in correspondence with the end of the strengthening system. Changing the failure mode from brittle (failure at the hinge-point) to ductile (elongation of the beam in both directions) considerably increased the amount of energy dissipated (+85%).



REFERENCES:

Del Vecchio C, Di Ludovico M, Balsamo A, Prota A. 2018. Seismic retrofit of real beam-column joints using Fibre Reinforced Cement (FRC) composites. *ASCE Journal of Structural Engineering* Vol. 144, issue 5, DOI: 10.1061/(ASCE)ST.1943-541X.0001999

Del Vecchio C, Di Ludovico M, Balsamo A, Prota A, Manfredi G, (2017), *Innovative solutions for seismic retrofit of existing RC buildings with poor quality concrete. COST Action TU1207, Next Generation Design Guidelines for Composites in Construction, Proceedings of the End of Action Conference, 3-5 April 2017 Budapest, Hungary, page 8*

Test report UNINA - *Experimental tests on existing RC members strengthened with thin jacketing of high performance fibre reinforced cement composite, shrinkage-free and high ductility, with stiff steel fibres, namely PLANITOP HPC (Mapei S.p.A.)*



ReLUIS – DPC project “SEISMIC ENGINEERING - UNIVERSITY LABORATORY NETWORK” PE 2014-2018

Experimental testing on full-scale, reinforced concrete pillars taken from buildings with earthquake damage

YEAR: 2016

LOCATION: Federico II University of Naples - Faculty of Structural Engineering and Architecture

LEAD RESEARCHERS: C. Del Vecchio, M. Di Ludovico, A. Balsamo, A. Prota

EXPERIMENTAL TESTING: The tests were conducted on two pillars taken from a reinforced concrete building from the 1960's in L'Aquila that had been damaged by the earthquake that struck the city in 2009. The structural frame system was characterised by poor quality concrete and steel reinforcement typically found in buildings designed before the 1970's. The strengthening package was applied by firstly removing the outer layer of concrete down to a depth of around 40 mm and then reintegrating the concrete with **PLANITOP HPC** and **FIBRE HPC**.

RESULTS: The tests demonstrated the effectiveness of the **PLANITOP HPC** and **FIBRE HPC** strengthening system in delaying the compressive failure of the pillar by increasing its compressive strength by around 37%. Also, the final crack formation showed how the strengthening system prevented the longitudinal steel reinforcement towards the outer part of the pillars from buckling.

REFERENCES:

Test report UNINA - Experimental tests on existing RC members strengthened with thin jacketing of high performance fibre reinforced cement composite, shrinkage-free and high ductility, with stiff steel fibres, namely PLANITOP HPC (Mapei S.p.A.)





MAPEI S.p.A.

Experimental tests on full-size brick-concrete floors cast on site integrated with a layer of HPC on the extrados face

YEAR: 2016

LOCATION: La.Sp.ed. Tirreno S.r.l laboratory – Cava dè Tirreni (Salerno) – Test campaign designed by the Faculty of Structural Engineering and Architecture of the Federico II University of Naples

LEAD RESEARCHERS: A. Balsamo, G. Morandini, I. Iovinella, G. Maddaloni, A. Prota, M. Di Ludovico

EXPERIMENTAL TESTING: Two identical, brick-concrete floors were built next to each other and were separated by creating a suitable joint. The floors were designed to represent floors for civil use typically found in building from the 1960's and 1970's and were dimensioned according to the acceptable stress approach typically adopted during that period. The floors were of the single-span type and the distance between the end supports was 5 metres. Their overall height was 200 mm (180 mm of brickwork and 20 mm of topping on the extrados, the equivalent of 1/25 of the gap between the end supports). One of the floors was tested after it had been integrated with a compact layer (around 20 mm) of **PLANITOP HPC FLOOR** on the extrados face of the topping after its surface had been prepared adequately. The other floor was tested "as-built".

RESULTS: After comparing the floor without strengthening and the identical floor strengthened with **PLANITOP HPC FLOOR**, the following was found:

- the flexural strength of the strengthened floor was 50% higher;
- the initial rigidity of the strengthened floor was 220% higher and there was less deflection in the floor under service loads;
- ductility of the strengthened floor increased by 125% and there was a resulting increase in plastic deformation.

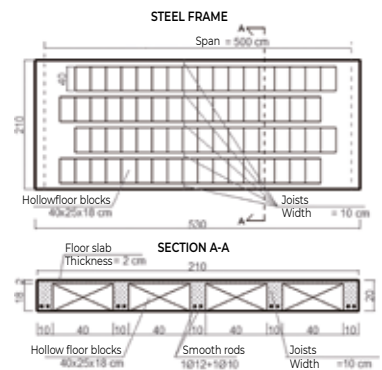
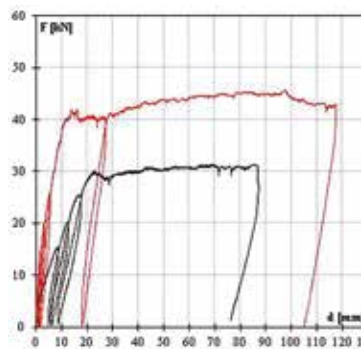
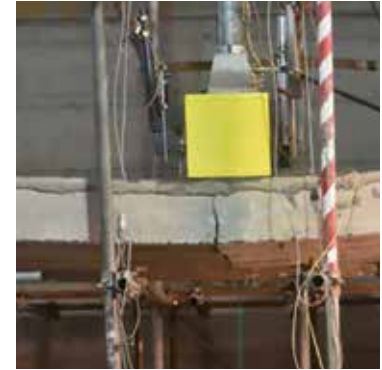

REFERENCES:

UNINA Test Report – Testing on full-scale brick-concrete floors cast on site strengthened with an additional layer on the extrados face of topping with one-component, high-performance, high-ductility, free-flowing, compensated-shrinkage cementitious mortar, namely PLANITOP HPC Floor (Mapei S.p.A.)

1.4

MAPEWRAP EQ SYSTEM

1.4.1

DEFINITION, MATERIALS

AND AREAS OF USE

To safeguard non-structural elements, an innovative system to provide protection against seismic activity is represented by the MAPEWRAP EQ SYSTEM. The system is presented in the form of “seismic wallpaper”, allowing people more time to evacuate buildings in the event of an earthquake.

One of the most critical aspects of earthquakes is to evacuate buildings due to the damage or the collapse of secondary elements (partitions, buffer walls, ceilings, etc.).

Applying the **MAPEWRAP EQ SYSTEM** improves the distribution of loads induced by dynamic stresses in structures and reduces the seismic vulnerability of secondary partitions, by making the strengthened elements more ductile. The system also improves the performance

characteristics of brick-concrete floors and reduces their risk of collapse. Increasing the amount of time available can prove to be extremely important to all those people present in a building in order for them to exit the building unharmed.

The reinforcing system also adheres perfectly to rendered surfaces, as long as they are sound and compact. The **MAPEWRAP EQ SYSTEM** may be applied to both the inside and the outside of buildings.



The earthquake that hit L'Aquila in 2009 highlighted the importance of the risk posed by the collapse of non-structural elements, such as buffer and partition walls, due to stresses induced by the earthquake. Even though this issue has been widely documented, this event underlined the need for even more attention to this problem, and it is no coincidence that photographs of the earthquake in L'Aquila have become a familiar sight to those working in this field.

Since 2009 various anti-collapse systems have been developed and publicised, often starting from proposals contained in the Guidelines issued by the Italian Civil Defence Organisation published after the earthquake in L'Aquila.

Similarly to a simple collapse of the facades of masonry buildings, brick partitions also collapse around a cylindrical hinge-point at their base. In order to make them more stable, including when subjected to seismic loads and stresses, the equilibrium of their rotation around the hinge-point needs to be verified, taking into consideration the effect of the seismic loads exerted by the anti-collapse system. Detachment may take place in correspondence with either the structural or the non-structural element, which means it is necessary to verify which of the two values representing adhesion to the substrate is the lowest and, therefore, the one that needs to be taken into consideration.

The MAPEWRAP EQ SYSTEM improves the distribution of loads induced by dynamic stresses and reduces the seismic vulnerability of secondary partitions by making the strengthened elements more ductile.

MAPEWRAP EQ NET

MAPEWRAP EQ ADHESIVE

		
<p>Chemical nature</p>	<p>Bi-directional, primed glass fibre fabric to protect secondary partitions in buildings from seismic loads.</p>	<p>One-component, ready-to-use, polyurethane dispersion-based adhesive with very low emission of volatile organic compounds (VOC) for impregnating MAPEWRAP EQ NET bi-directional, primed glass fibre fabric.</p>

1.4.2 EXPERIMENTAL TESTING



ReLUIS/DPC RS8 project “Seismic capacity of non-structural components”

Experimental testing on full-scale brick partitions at risk of collapse

YEAR: 2016

LOCATION: Federico II University of Naples - Faculty of Structural Engineering and Architecture

LEAD RESEARCHERS: G. Magliulo, F. Celano, A. Balsamo, A. Prota, G. Morandini, I. Iovinella

EXPERIMENTAL TESTING: The test set-up was as follows:

- a three-dimensional steel frame to transfer input from seismic loads to the test piece;
- test pieces consisting of hollow-brick partitions strengthened with **MAPEWRAP EQ SYSTEM**;
- a shaking table to carry out ten dynamic tests.

RESULTS: At the end of the experimental test campaign none of the walls had collapsed, demonstrating the effectiveness of the system.

REFERENCES:

G.Magliulo, F.Celano, A. Balsamo, A. Prota 2016. *Shaking table tests on infill retrofitted with foam and net.* Available at <http://www.reluis.it>.

UNINA test report – *Dynamic testing on hollow-brick partition walls with a strengthening package to prevent collapse and in-plane failure: MAPEWRAP EQ SYSTEM (Mapei S.p.A.)*

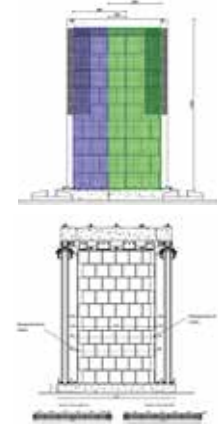
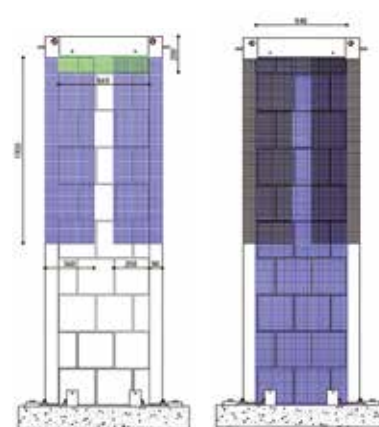
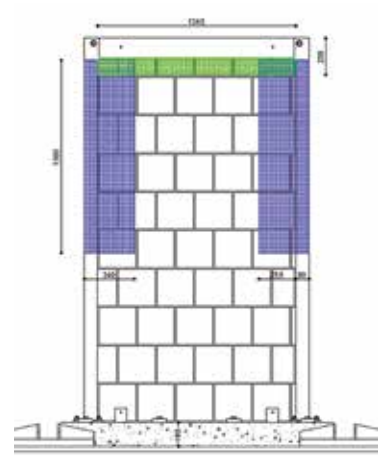
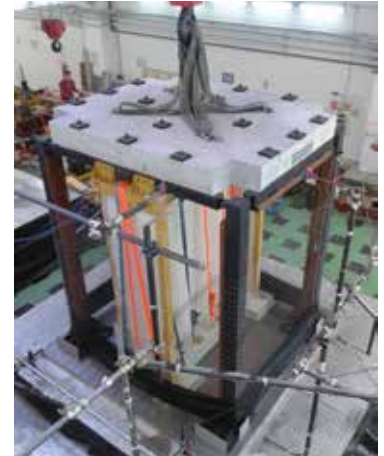



MAPEI S.p.A.

Experimental testing on a full-scale brick-concrete floor at risk of collapse

YEAR: 2016

LOCATION: La.Sp.ed. Tirreno S.r.l. laboratory – Cava dè Tirreni (Salerno) – Test campaign designed by the Faculty of Structural Engineering and Architecture of the Federico II University of Naples

LEAD RESEARCHERS: A. Balsamo, M. Di Ludovico, G. Maddaloni, I. Iovinella, A. Prota, G. Morandini

EXPERIMENTAL TESTING: A series of load tests was conducted on a brick-concrete floor designed to represent floors for civil use typically found in building from the 1960's and 1970's. The floor was dimensioned according to the acceptable stress approach to simulate collapse phenomenon and validate the effectiveness of the system.

RESULTS: Using **MAPEWRAP EQ SYSTEM** as a strengthening system to prevent collapse of the floor demonstrated the system's effectiveness in stopping damaged and detached bricks from falling due to deformation of the floor.

REFERENCES:

A. Balsamo, M. Di Ludovico, G. Maddaloni, G. Morandini A. (2016). "A new FRP based technique to restore damaged cast in place rc floors: experimental validation", CICE – 8th International Conference on Fibre-Reinforced Polymers (FRP) Composites in Civil Engineering, Hong Kong, China, December 2016

Balsamo A., Di Ludovico M., Maddaloni G., Iovinella I., Prota A. (2016). "An innovative anti-collapse system for cast in place r.c. floors: experimental validation and case study", InConcreto magazine No. 142

UNINA test report – Testing on a full-scale brick-concrete floor with an anti-collapse system (MAPEWRAP EQ SYSTEM, Mapei S.p.A.)

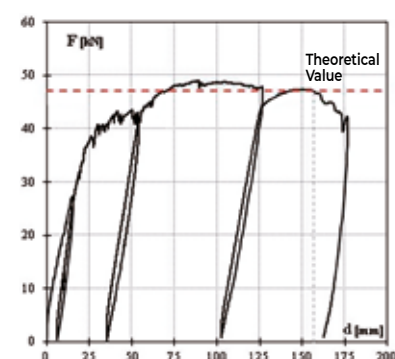
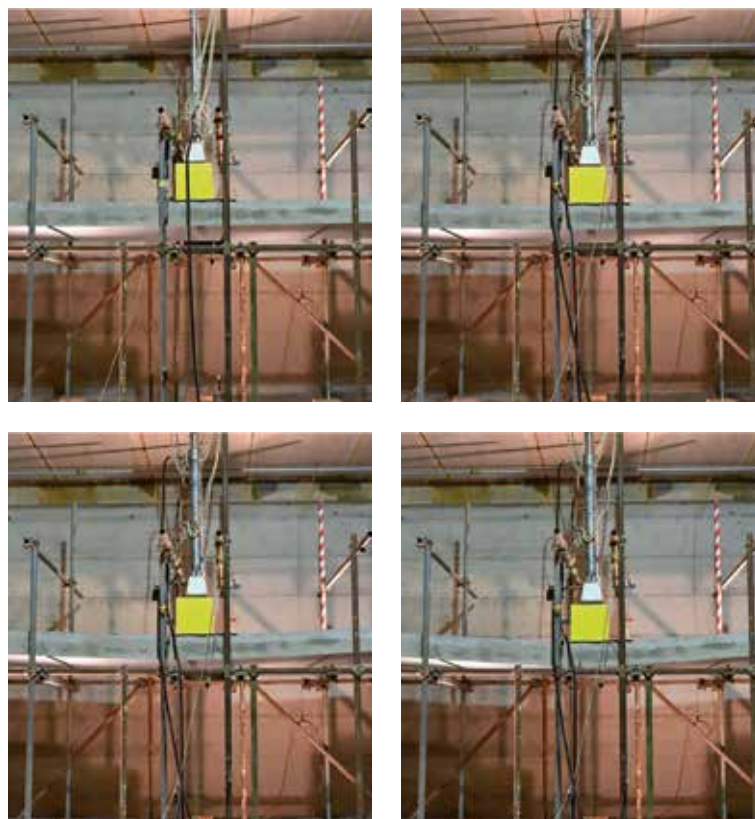

1.5

COMPLEMENTARY SYSTEMS

1.5.1

STAINLESS STEEL



HELICAL BARS

MAPEI STEEL BAR and MAPEI STEEL DRY are helical bars made from AISI 304 and AISI 316 stainless steel characterised by their very high strength and chemical stability.

The special helical shape of the bars enables them to form a solid anchor and guarantee a considerably high level of mechanical adherence.

MAPEI STEEL BAR

MAPEI STEEL DRY

		
Material	AISI 304 or AISI 316 stainless steel	
Diameter	6 mm	6, 8, 10, 12 mm
Length available	10 m	25, 40, 60, 80, 100 cm
Typical areas of use	<ul style="list-style-type: none"> • Reinforced pointing for joints on exposed masonry walls. • Tying masonry walls that have not been keyed together. • Localised crack stitching repairs. 	<ul style="list-style-type: none"> • Connection of load-bearing cavity-wall. • Reinforced stitching for corner walls and "T" intersections. • Localised crack repairs in masonry. • Connections between wooden floors and compact structural screeds made from PLANITOP HPC FLOOR T. • Connecting wooden floor joists to masonry walls.

1.5.2

CHEMICAL

ANCHORS

The MAPEFIX range proposes targeted solutions for different anchoring requirements; from light loads to the most demanding and critical structural loads.

The reliability of products from the **MAPEFIX** range is demonstrated by their compliance with Eurocode standards and by the indications in Technical Reports issued by EOTA, which define the most severe guidelines in the anchoring field (ETAG 001, TR029, TR023 and ETAG 029).

MAPEI also has a free software program available, **MAPEFIX SOFTWARE DESIGN**, which has been developed to comply with current European standards when calculating the correct dimensions for an anchor using **MAPEFIX** resins.



Technicians and design engineers can rely on the free software package MAPEFIX SOFTWARE DESIGN to help calculate the correct dimensions for MAPEFIX anchors.

MAPEFIX PE WALL

MAPEFIX VE SF

MAPEFIX EP470 SEISMIC

			
Chemical base	Styrene-free polyester	Styrene-free vinyl ester	Pure epoxy
Start setting time (+20°C)	6 mins.	6 mins.	50 mins.
Final hardening time (+20°C)	45 mins.	45 mins.	16 hours
Masonry (ETAG 029)	(M8-M12)		
Concrete (ETA option 1 and 7)		(M12-M30/ ϕ 12- ϕ 32)	(M12-M24)
Seismic certification (C1 or C2)		(M12-M30/ ϕ 12- ϕ 32)	(M16-M24)
Anchoring rebar for second pours (ETA Rebar)		(ϕ 8- ϕ 25)	(ϕ 8- ϕ 32)
Resistance to fire		(120 mins.)	

1.5.3

INJECTION SYSTEMS

FOR MASONRY

Slurry is generally injected to homogenise the behaviour of masonry by saturating the cavities and reintegrating material that has been dissolved.

Injecting slurry is recommended to bind fine aggregates, such as when filling cement core walls or rough stone walls. To prevent the formation of adjacent areas with different levels of rigidity and strength, the entire wall needs to be injected.

Injecting slurry also reintegrates the original building mortar that has either deteriorated or become crumbly to even out the contact surface between the various building blocks.

If the quality of the layout of the building blocks is inadequate due to a lack of sufficient connections between the various facings, whether the masonry is damaged or still sound, apart from injecting slurry, the facings will need to be reconnected, such as by stitching.

Injecting slurry can be very useful in areas where there are concentrated loads and possible localised punch-loads, such as in correspondence with supports for beams or anchor plates.



Injecting slurry can be very useful in areas where there are concentrated loads and possible localised punch-loads

MAPEI products specifically formulated for injecting are as follows:

	MAPE-ANTIQUE I	MAPE-ANTIQUE I-15	MAPE-ANTIQUE F2I	MAPEWALL INJECT&CONSOLIDATE
				
Material	Free-flowing natural hydraulic lime and Eco-Pozzolan mortar (cement-free)			Lime-based mortar
Compressive strength	18 [MPa]	15 [MPa]	10 [MPa]	15 [MPa]

Mixes for injection purposes must have a low content of water-soluble salts, they must be physically and chemically compatible with the components used to build old walls and they must also have similar mechanical characteristics.

Mixes for injection purposes with these characteristics have the following advantages:

- highly plastic with a low water/binder ratio;
- mechanical characteristics comparable with those of the masonry structure so that the structural behaviour of restored masonry is homogeneous and isotropic;
- low content of water-soluble salts;
- high breathability;
- high penetration capacity so that even small cracks and cavities are filled;
- no segregation of the mix during injection;
- chemically compatible with the materials used in historic buildings;
- low hydraulic shrinkage.

CARBOTUBE SYSTEM is a system made up of pre-formed, hollow carbon-fibre bars impregnated with epoxy resin with a high level of tensile strength. The system is used for the structural strengthening of concrete, wooden and masonry elements and may also be used in combination with injected hi-flow slurry to carry out reinforced stitching in masonry.

CARBOTUBE | Hollow carbon fibre bars

	
Tensile modulus of elasticity	170 GPa
Diameter	est. 10 mm; int. 8 mm





1.5.4

MAPEWRAP

FIOCCO

Uni-directional fibre cord

The products in the **MAPEWRAP FIOCCO** range are cords made from high-strength, uni-directional carbon, glass, basalt and steel fibres that are then impregnated with two-component, super-plastic resin (such as **MAPEWRAP 21** or **MAPEWRAP 31**) at the moment of use.

	MAPEWRAP C FIOCCO	MAPEWRAP B FIOCCO	MAPEWRAP G FIOCCO	MAPEWRAP SG FIOCCO
				
Material	Carbon	Basalt	Glass	Steel
Diameter	6, 8, 10, 12 [mm]	3, 10, 12 [mm]	6, 8, 10, 12 [mm]	5, 10 [mm]
Tensile strength	4830 [MPa]	2900 [MPa]	2290 [MPa]	2750 [MPa]
Typical areas of use	 <p>Connection system; may be used in combination with the MAPEWRAP SYSTEM, CARBOPLATE SYSTEM and FRCM System</p>			

1.5.5

MAPEWRAP CONNECTOR

MAPEWRAP CONNECTORS are preformed connectors made up of a rigid stem and one end with loose fibres that need to be splayed out at the moment of use.

MAPEWRAP FIOCCO and **MAPEWRAP CONNECTOR** may be used in combination with fabrics from the **MAPEWRAP** range, sheets from the **CARBOPLATE** range and strengthening systems in which **MAPEGRID** mesh is used to improve their anchorage, particularly when applying packages to improve flexural and shear strength.



Unlike **MAPEWRAP FIOCCO**, the rigid stem of **MAPEWRAP CONNECTOR**

is preformed and does not need to be impregnated the day before. The advantage of this type of connector is that it is easier and quicker to apply than **MAPEWRAP FIOCCO** but they come in fixed lengths and cannot be modified.

MAPEWRAP FIOCCO, on the other hand, may be made to suit on site and the length of the rigid stem and the fibres to be splayed out can be of any length.

MAPEWRAP C CONNECTOR

MAPEWRAP G CONNECTOR

		
Material	Carbon	Glass
Diameter	6, 8, 10 [mm]	10 [mm]

1.5.6 EXPERIMENTAL TESTING



PROVACI project (Technology for the Seismic Protection and Promotion of Complexes of Cultural Interest) STRESS DISTRICT Experimental test campaign on full-scale masonry cornerstones

YEAR: 2015

LOCATION: Federico II University of Naples - Faculty of Structural Engineering and Architecture

LEAD RESEARCHERS: A. Balsamo, M. Di Ludovico, A. Prota, G. Maddaloni, N. Iuliano

EXPERIMENTAL TESTING: Testing was conducted on a full-scale member representing a “T” intersection between two walls on the ground floor of a two-storey tuff masonry building, with a reduced amount of keying between the two orthogonal walls. After being damaged the test piece, representing a simple, out-of-plane collapse mechanism with the formation of a driven wedge in the spine wall, was repaired and consolidated using traditional methods (the cracks were injected with cement-free, hi-flow lime and Eco-Pozzolan-based mortar - **MAPE-ANTIQUE F21**) and then strengthened using the reinforced stitching method, in which the standards steel bars were replaced with an innovative system consisting of hollow pultruded carbon fibre tubes (**CARBOTUBE**) with extra stainless steel threads made from uni-directional fabric (**MAPEWRAP S FABRIC**) wound in a spiral pattern running longitudinally along the tubes, to reduce the chance of the tubes being sheared and to improve their grip with the injected mortar. The injected mortar in this case was super-plastic slurry made from natural hydraulic binders and ultra-fine sand (**MAPE-ANTIQUE I**).

RESULTS: The innovative strengthening technique allowed the overall strength to be increased significantly while reducing the keying between the two orthogonal walls. This allowed the strengthened



“T” intersection to dissipate more energy than the test piece without strengthening, and without any significant modification to its initial rigidity, and prevent the collapse mechanism that had been observed in the test piece without strengthening.

REFERENCES:

Maddaloni G., Di Ludovico M., Balsamo A., Prota A. (2016), “Out-of-plane experimental behaviour of t-shaped full scale masonry wall strengthened with composite connections”, *Composites Part B* 93 (2016) 328 and 343

Balsamo A., Di Ludovico M., Morandini G., Maddaloni G., (2016) “Out-of-plane experimental behaviour of t-shaped full scale masonry wall strengthened with a composite system”, *REHABEND 2016 Euro-American Congress on Construction Pathology, Rehabilitation Technology and Heritage Management, Burgos, Spain, May 2016*

Maddaloni G., Balsamo A., Di Ludovico M., Prota A., (2016). “Out of plane experimental behaviour of T-shaped full scale masonry orthogonal walls strengthened with innovative composite systems”, *4th International Conference on Sustainable Construction Materials and Technologies, Las Vegas, Nevada, USA, August 2016*

Balsamo A., Di Ludovico M., Iuliano N., Maddaloni G., Prota A., (2015) “Experimental analysis of the out-of-plane behaviour of full-scale T-shaped walls”, *XVI Anidis convention, 2015, L’Aquila, Italy, September 2015*



STRUCTURAL STRENGTHENING



2

TECHNICAL SOLUTIONS

Strengthening systems
sheets



2.1

STRENGTHENING SYSTEMS

FOR REINFORCED CONCRETE BUILDINGS



Following an analysis of numerous earthquakes that have hit Italy and many other countries around the world over the course of the last few decades, it has been noticed that reinforced concrete structures suffer from the same type of failure mechanisms or “typical” types of damage, and that the trigger for these failure mechanisms or this type of damage may be limited or even eliminated by implementing various strengthening techniques.

Depending on the wished result, various types of strengthening packages may be designed:

- A.** Increasing strength and/or rigidity by adding an external frame, wind barriers or RC dividing walls;
- B.** Increasing strength and/or rigidity by increasing the section of pillars with RC or metal bracing;
- C.** Increasing the deformation capacity and ductility of structures with **FRP banding** or by **jacketing with high-performance concrete with added fibres**.

The interventions mentioned in point C are particularly beneficial because the overall deformation capacity of a structure is improved by targeting only certain

TYPICAL COLLAPSE MECHANISMS IN RC STRUCTURES



Soft-storey collapse



Failure of beam-pillar joints



Failure of stocky pillars



Construction defects



Defects in second concrete casting



Instability of steel reinforcement



Failure due to combined compressive and bending loads



Shear failure of pillars



Collapsed floors



Beams hit by impact loads

areas to give individual elements a **higher level of ductility** or to **correct strength hierarchy**; these interventions are typically implemented in structures designed for vertical loads only.



The **FRP** and **HPC systems** described in this manual achieve these objectives, but also offer considerable benefits in terms of cost, installation times, ease of installation,

the amount of internal space required, durability and, above all, they have **less influence on a structure's original overall mass and rigidity**.

STRENGTHENING SYSTEMS

FOR REINFORCED CONCRETE BUILDINGS



1. SUBSTRATE PREPARATION AND RESTORATION OF RC ELEMENTS

- 1.a  Substrate preparation
 - 1.b  Restoring joists and slabs
 - 1.c  Restoring beams, pillars and beam-pillar joints
-

2. FLEXURAL STRENGTHENING OF JOISTS AND SLABS

- 2.a  Cladding with FRP: **MAPEWRAP SYSTEM** fabrics
 - 2.b  Cladding with FRP: **CARBOPLATE SYSTEM** plates
-



3. FLEXURAL STRENGTHENING OF BEAMS

- 3.a  Cladding with FRP: **MAPEWRAP SYSTEM** fabrics
 - 3.b  Cladding with FRP: **CARBOPLATE SYSTEM** plates
 - 3.c  Jacketing with the HPC SYSTEM: **PLANITOP HPC**
-

4. SHEAR STRENGTHENING OF BEAMS

- 4.a  Cladding with FRP: **MAPEWRAP SYSTEM** fabrics

5. STRENGTHENING OF PILLARS

- 5.a  Binding pillars to increase confinement and shear strength with FRP: **MAPEWRAP SYSTEM** fabrics
 - 5.b  Combined compressive and bending strengthening by cladding with FRP: **MAPEWRAP SYSTEM** fabrics
 - 5.c  Jacketing with the HPC SYSTEM: **PLANITOP HPC**
-



6. STRENGTHENING OF BEAM-PILLAR CORNER JOINTS

- 6.a  Cladding with FRP: **MAPEWRAP SYSTEM** fabrics
 - 6.b  Jacketing with the HPC SYSTEM: **PLANITOP HPC**
-

7. STRENGTHENING OF BEAM-PILLAR PERIMETER JOINTS

- 7.a  Cladding with FRP: **MAPEWRAP SYSTEM** fabrics
 - 7.b  Jacketing with the HPC SYSTEM: **PLANITOP HPC**
-

8. STRENGTHENING OF FLOOR SLABS WITH STRUCTURAL SCREED

- 8.a  Strengthening level floor slabs with a low-thickness structural screed using the HPC SYSTEM: **PLANITOP HPC FLOOR**
- 8.b  Strengthening sloping floor slabs with a low-thickness structural screed using the HPC SYSTEM: **PLANITOP HPC TIXO**

SUBSTRATE PREPARATION AND RESTORATION OF RC ELEMENTS

SUBSTRATE PREPARATION

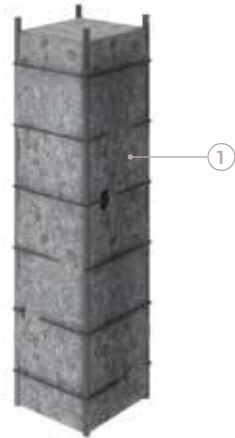

← 1 | EXISTING CONCRETE

APPLICATION PROCEDURE



Before carrying out any strengthening work on structures made from RC, it is very important to remove any finishing coats or layers from the surface (such as paint or render) and to verify the condition of the underlying structural element.

If the section in RC is sound and compact with adequate mechanical properties, and has no cracks or material or substances on the surface that could affect adhesion of the strengthening layers to be added (such as form-release compound, oil, grease, paint, rust, etc.), the surface of the concrete will just need to be cleaned and de-dusted.

If the section in RC is in poor condition and/or the steel reinforcement is rusty, it will be necessary to carry out adequate **preparation of the substrate**. Correct preparation is very important in order to achieve effective, durable results and consists of the following steps:

- Removal of the areas of concrete that are cracked, detached or loose to create a substrate that is sound and compact with adequate mechanical properties (photos A and B). Upon completion of this part of the preparation work the surface of the concrete should have a surface roughness of at least 5 mm.
- Any steel reinforcement left exposed after removing damaged concrete will need to be cleaned to remove the rust from the surface (photos C and D).
- A thorough clean of all the surfaces to be restored to eliminate any unwanted material, oil, grease, paint and rust and to remove traces of dust from the surface (photo E).

The steps mentioned above to clean and prepare the substrate may be carried out using various methods, depending on specific site conditions, and with both power tools and hand tools. Below are the most widely adopted methods to prepare substrates.

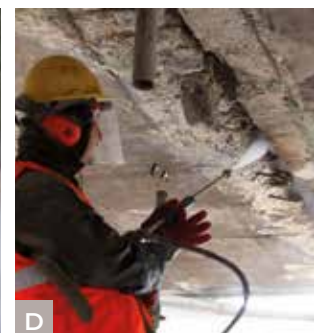

Sanding/roughening

Abrasion of cementitious surfaces with emery cloth, either manually or using a sanding machine, to roughen the surface of the substrate and remove surface deposits. All residues must then be removed with a vacuum cleaner or by rinsing the surface, as long as this does not affect the layer to be applied on the substrate.

Brushing steel surfaces

Cleaning the surface of steel elements, such as clamps, tie-rods and steel reinforcement in the area to be reintegrated, with a hand-brush or power-brush.

Brushing the surface of concrete

The surface of the concrete needs to be cleaned to remove any cement laitance and loose material.

Hydro-blasting

Hydro-blasting of cementitious substrates using high pressure water jets to eliminate loose and/or detached parts and organic and inorganic pollutants (soluble salts).

Hydro-scarifying

Surface treatment for concrete using jets of water at very high

pressure jets (more than 800 atm) and special equipment to remove all loose and detached parts, pollutants and rust from steel reinforcement and to create a sufficiently rough surface for the restoration mortar.

Hydro-sandblasting

Treatment for cementitious substrates using silica sand and high pressure water to remove water-soluble pollutants, foreign bodies and loose parts to create a sound, compact surface.

Sandblasting

Treatment for cementitious surfaces and steel reinforcement using silica sand and sandblasting equipment to remove rust and loose parts.

Bush-hammering

Hammering the surface of concrete to form a very rough substrate to guarantee a good keying surface for restoration mortar, render, etc.

De-dusting

Removal of dust and crumbling areas from surfaces to be restored (with smoothing and levelling compound or paint) using an industrial vacuum cleaner and/or compressed air.

SUBSTRATE PREPARATION AND RESTORATION OF RC ELEMENTS

RESTORING JOISTS AND SOLID FLOORS

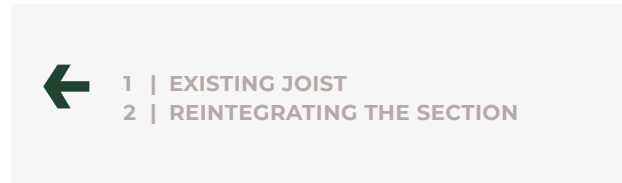

APPLICATION PROCEDURE

After preparing the substrate (SHEET 1.A) proceed as follows:

→ Sealing cracks

Before carrying out other phases of the activity, any cracks must be treated by opening them (with a hand grinder, for example). Then, after removing all traces of dust, they must be sealed by filling or injecting them with **EPOJET** two-component, super-plastic epoxy resin for injecting and anchoring and broadcast with quartz sand (wet on wet) to create a good keying surface for the next product.

→ Protection of steel reinforcement

After removing the rust, treat the steel reinforcement by brush-applying two coats of **MAPEFER 1K** one-component or **MAPEFER** two-component, anti-corrosion cementitious mortar (photo A). Both products are made from cementitious binders, powdered polymers and corrosion inhibitors and their specific function is to prevent the formation of rust.

→ Restoring the section of RC

Clean all surfaces to be restored (beams, pillars and beam-column joints) by hydro-blasting and saturate them with water to leave a dry surface (s.s.d. condition). The concrete removed from around the steel reinforcement may then be reintegrated with one of the following products:

MAPEGROUT T60 one-component, normal-setting, compensated-shrinkage, R4 class thixotropic mortar for layers 1 to 4 cm thick;

MAPEGROUT THIXOTROPIC one-component, normal-setting, compensated-shrinkage, R4 class thixotropic mortar for layers 1 to 3.5 cm thick;

MAPEGROUT BM two-component, normal-setting, compensated-shrinkage, R4 class thixotropic mortar with a low modulus of elasticity (22 GPa) for layers 1 to 3.5 cm thick;

PLANITOP SMOOTH & REPAIR R4 one-component, rapid-setting, compensated-shrinkage, R4 class thixotropic mortar for layers 0.3 to 4 cm thick (photos B, C and D);

MAPEGROUT HI-FLOW one-component, normal-setting, compensated-shrinkage, R4 class mortar for layers 1 to 4 cm thick.



↓ NOTES

1. When preparing the mortar add **MAPECURE SRA**, a special shrinkage-reducing agent, at a rate of 0.25% of the weight of the mortar.
2. Apply the mortar with a spreader, trowel or by spray within the application temperature range indicated in the relative Technical Data Sheet. When the section to be reintegrated is thicker than the indicated amount, the mortar must be applied in several layers.
3. Before applying the strengthening system wait until the mortar is fully cured.

SUBSTRATE PREPARATION AND RESTORATION OF RC ELEMENTS

RESTORING BEAMS, PILLARS AND BEAM-PILLAR JOINTS

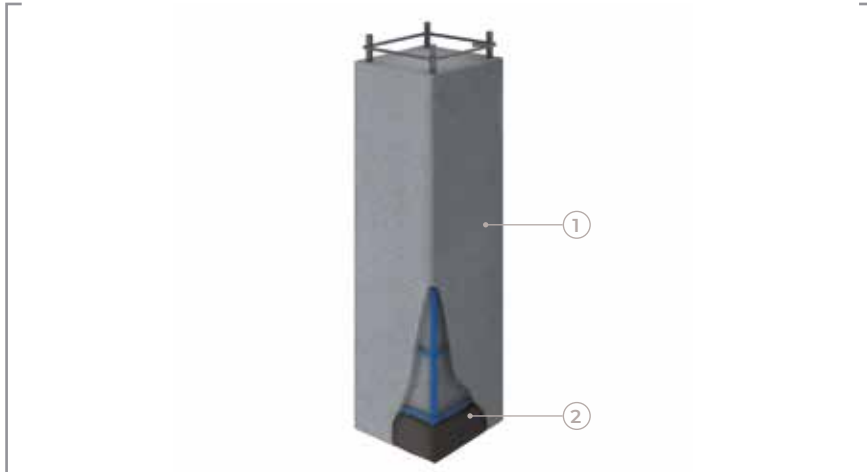

- ← 1 | EXISTING PILLAR
2 | REINTEGRATING THE SECTION

APPLICATION PROCEDURE

After preparing the substrate (SHEET 1.A) proceed as follows:

1. Sealing cracks

Before carrying out other phases of the activity, any cracks must be treated by opening them (with a hand grinder, for example). Then, after removing all traces of dust, they must be sealed by filling or injecting them with **EPOJET** (two-component, super-plastic epoxy resin for injection and anchoring) and broadcast with quartz sand (wet on wet) to create a good keying surface for the next product.

2. Protection of steel reinforcement

After removing the rust, treat the steel reinforcement by brush-applying two coats of **MAPEFER 1K** one-component or **MAPEFER** two-component, anti-corrosion cementitious mortar (photos A and B). Both products are made from cementitious binders, powdered polymers and corrosion inhibitors and their specific function is to prevent the formation of rust.

3. Restoring the section of RC

Clean all surfaces to be restored (joists and RC floor slab) by hydro-blasting and saturate them with water to leave a dry surface (s.s.d. condition). The concrete removed from around the steel reinforcement may then be reintegrated with one of the following products (photos C, D and E):

- **MAPEGROUT BM** two-component, normal-setting, compensated-shrinkage, R4 class thixotropic mortar with a low modulus of elasticity (22 GPa) for layers 1 to 3.5 cm thick;
- **PLANITOP SMOOTH & REPAIR R4** one-component, rapid-setting, compensated-shrinkage, R4 class thixotropic mortar for layers 0.3 to 4 cm thick.
- **MAPEGROUT HI-FLOW**, one-component, normal-setting, compensated shrinkage castable mortar, R4 class, for thicknesses between 1 and 4 cm per coat.

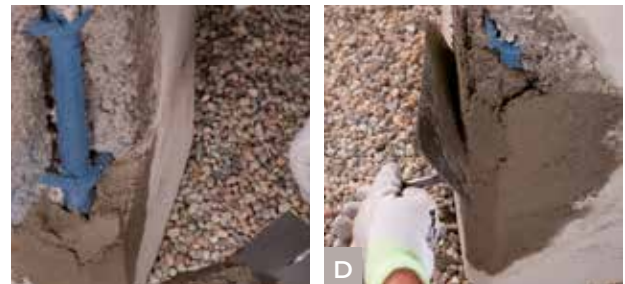

↓ NOTES

1. When preparing the mortar add **MAPECURE SRA**, a special shrinkage-reducing agent, at a rate of 0.25% of the weight of the mortar.
2. Apply the mortar with a spreader, trowel or by spray within the application temperature range indicated in the relative Technical Data Sheet. When the section to be reintegrated is thicker than the indicated amount, the mortar must be applied in several layers.
3. Before applying the strengthening system wait until the mortar is fully cured.

FLEXURAL STRENGTHENING OF JOISTS AND SLABS CLADDING WITH FRP: MAPEWRAP SYSTEM FABRICS

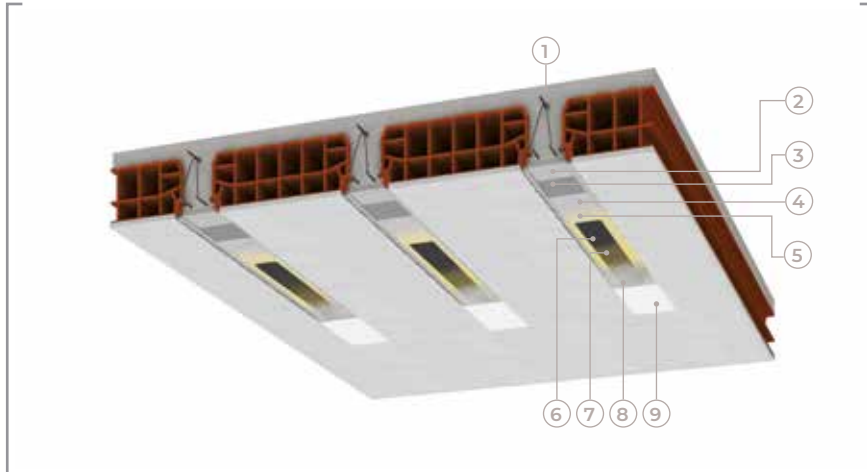

- ←
- 1 | EXISTING JOIST
 - 2 | REINTEGRATING THE SECTION
 - 3 | MAPEWRAP PRIMER 1
 - 4 | MAPEWRAP 11/12
 - 5 | MAPEWRAP 31
 - 6 | MAPEWRAP C UNI-AX
 - 7 | MAPEWRAP 31
 - 8 | QUARTZ 1.2
 - 9 | PLANITOP 200

APPLICATION PROCEDURE



Flexural strengthening for a floor is carried out by bonding strips of **MAPEWRAP** uni-directional carbon fibre fabric with resin along the intrados of the floor.

After **preparing the substrate** (SHEET 1.A) and carrying out any **restoration operations** required (SHEET 1.B), proceed as follows:

- Apply **MAPEWRAP PRIMER 1** two-component epoxy primer on the surface to be strengthened (photo A).
- While the primer is still fresh, apply an even layer 1.0-1.5 mm thick of **MAPEWRAP 11** or **MAPEWRAP 12** two-component epoxy putty (*) with a trowel (photo B).
- While the epoxy grout is still fresh, apply a layer of **MAPEWRAP 31** fluid epoxy resin to impregnate the fabric (photo C).
- Cut the **MAPEWRAP C UNI-AX** fabric to the length required with scissors.
- Lay the **MAPEWRAP C UNI-AX** on the resin and go over it with a **MAPEWRAP ROLLER** to eliminate any air bubbles (photo D).
- Apply a second layer of **MAPEWRAP 31** (photo E).
- Broadcast the resin while still fresh with dry **QUARTZ 1.2** sand (photo F).
- Wait at least 24 hours from applying the fabric and skim the surface with cementitious smoothing and levelling mortar from the **PLANITOP** range.

(*) If a longer workability time is required use **MAPEWRAP 12**.



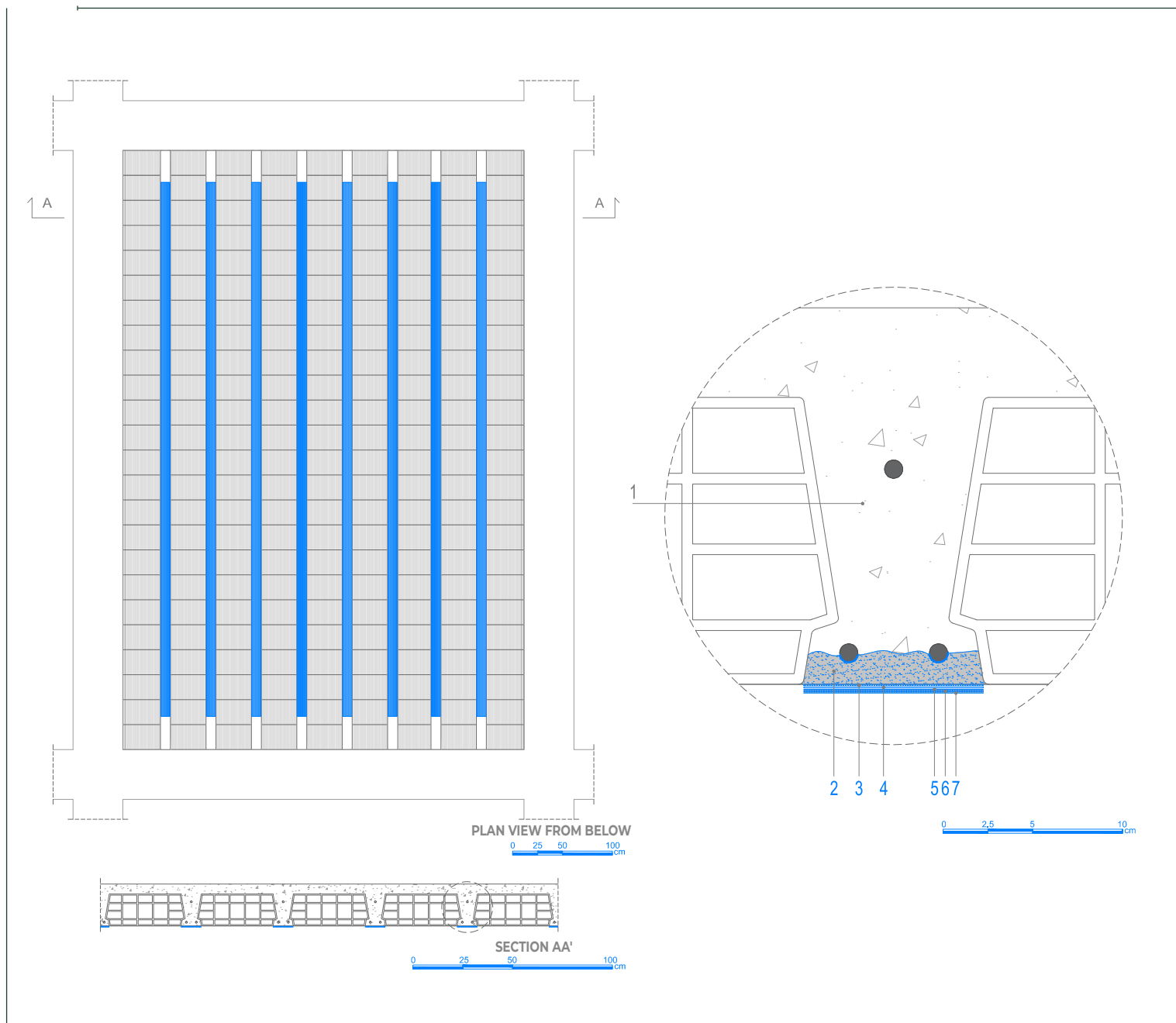

↓ NOTES

1. Use the **MAPEI STRUCTURAL DESIGN** calculation tool, which is compliant with CNR DT 200 guidelines, to define the characteristics of the **MAPEWRAP UNI-AX** fabric (type of fibre, weight, modulus of elasticity, dimensions and number of layers).
2. If more than one layer of fabric is applied (we recommend applying no more than three), they must be placed directly on the layer of **MAPEWRAP 31** while still fresh.
3. **MAPEWRAP C UNI-AX SYSTEM** is covered by Technical Evaluation Certificate (CVT) according to guideline No. 220, 09/07/2015 and the following No. 293, 29/05/2019 issued by the Supreme Council of Public Works.

SCAN THE QR CODE

To download strengthening Data sheets, Technical data sheets, DWG, structural calculation software and other useful tips

or **DOWNLOAD FROM OUR WEBSITE**
www.rinforzo-strutturale.it



FLEXURAL STRENGTHENING OF JOISTS AND SLABS CLADDING WITH FRP: CARBOPLATE SYSTEM PLATES

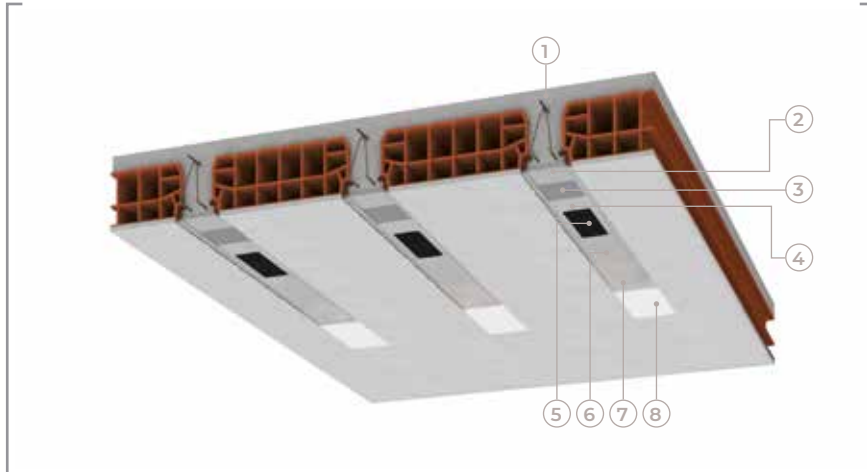

- ←
- 1 | EXISTING JOIST
 - 2 | REINTEGRATING THE SECTION
 - 3 | MAPEWRAP PRIMER 1
 - 4 | MAPEWRAP 11/12
 - 5 | CARBOPLATE
 - 6 | MAPEWRAP 11/12
 - 7 | QUARTZ 1.2
 - 8 | PLANITOP 200

APPLICATION PROCEDURE →

Flexural strengthening for a floor is carried out by bonding **CARBOPLATE** carbon fibre sheets with resin along the intrados of the floor joists. After **preparing the substrate** (SHEET 1.A) and carrying out any **restoration operations** required (SHEET 1.B), proceed as follows:

- Apply **MAPEWRAP PRIMER 1** two-component epoxy primer on the surface to be strengthened (photo A).
 - While the primer is still fresh, apply an even layer 1.0-1.5 mm thick of **MAPEWRAP 11**, **MAPEWRAP 12**, **ADESILEX PG1** or **ADESILEX PG2** two-component epoxy grout (*) with a trowel (photo B).
 - Cut the **CARBOPLATE** to the length required with a hand-grinder and remove the protective film (peel-ply) from the side the sheet is to be bonded (photo C).
 - Apply **MAPEWRAP 11**, **MAPEWRAP 12**, **ADESILEX PG1** or **ADESILEX PG2** on one side of the sheet (photo D).
 - Lay the **CARBOPLATE** on the resin and go over it with a MAPEWRAP ROLLER to eliminate any air bubbles (photos E and F).
 - Apply another layer of **MAPEWRAP 11**, **MAPEWRAP 12**, **ADESILEX PG1** or **ADESILEX PG2** two-component thixotropic epoxy adhesive on the **CARBOPLATE** with a flat trowel.
 - Broadcast the resin while still fresh with dry **QUARTZ 1.2** sand.
 - Wait at least 24 hours from applying the fabric and skim the surface with cementitious smoothing and levelling mortar from the **PLANITOP** range.
- (*) If a longer workability time is required use **MAPEWRAP 12** or **ADESILEX PG2**.



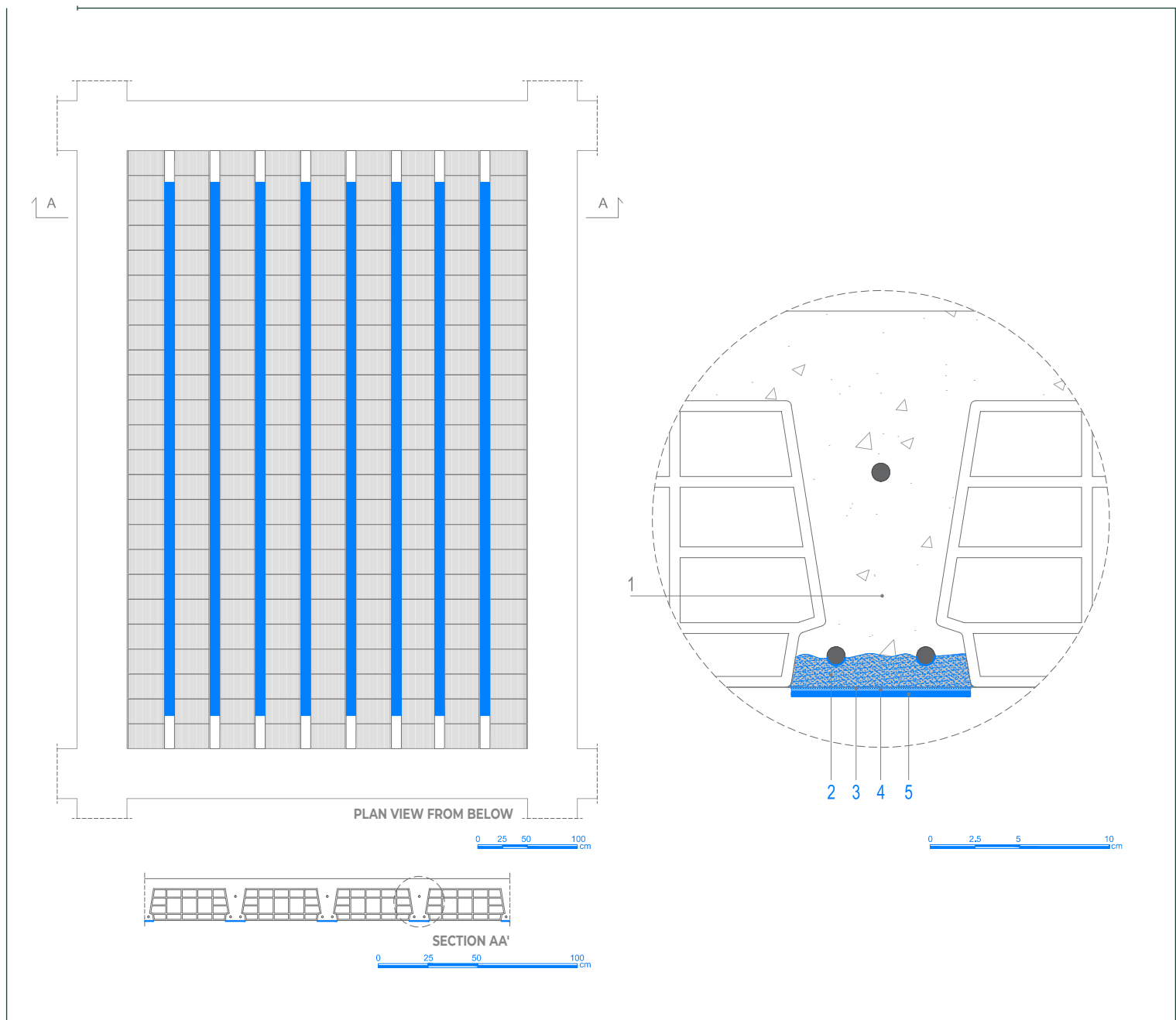

↓ NOTES

1. Use the **MAPEI STRUCTURAL DESIGN** calculation tool, which is compliant with CNR DT 200 guidelines, to define the characteristics of the **CARBOPLATE** sheets (modulus of elasticity, dimensions and number of layers).
2. If more than one layer of sheet is applied (we recommend applying no more than three), they must be placed directly on the layer of **MAPEWRAP 11** or **MAPEWRAP 12** while still fresh.
3. **CARBOPLATE SYSTEM** is covered by Technical Evaluation Certificate (CVT) according to guideline No. 220, 09/07/2015 and the following No. 293, 29/05/2019 issued by the Supreme Council of Public Works.

SCAN THE QR CODE

To download strengthening Data sheets, Technical data sheets, DWG, structural calculation software and other useful tips

or **DOWNLOAD FROM OUR WEBSITE**
www.rinforzo-strutturale.it



FLEXURAL STRENGTHENING OF BEAMS CLADDING WITH FRP: MAPEWRAP SYSTEM FABRICS

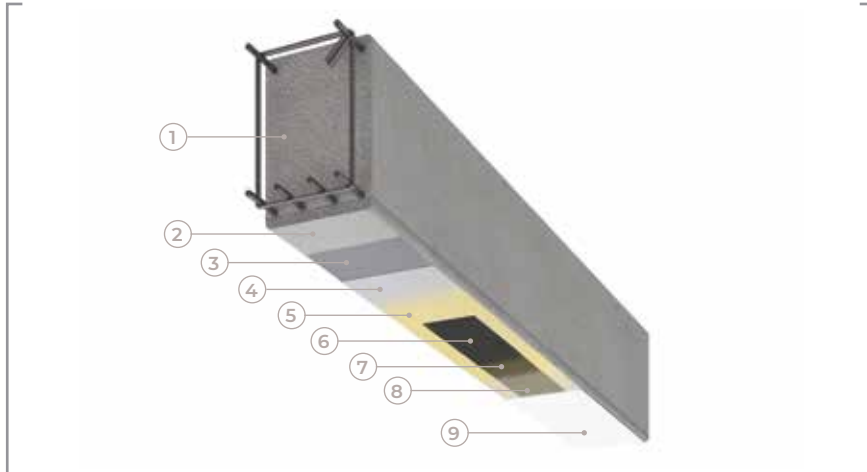

- 1 | EXISTING BEAM
- 2 | REINTEGRATING THE SECTION
- 3 | MAPEWRAP PRIMER 1
- 4 | MAPEWRAP 11/12
- 5 | MAPEWRAP 31
- 6 | MAPEWRAP C UNI-AX
- 7 | MAPEWRAP 31
- 8 | QUARTZ 1.2
- 9 | PLANITOP 200

APPLICATION PROCEDURE



Flexural strengthening for a beam is carried out by bonding **MAPEWRAP** uni-directional carbon fibre fabric lengthways along the beam with epoxy resin.

After **preparing the substrate** (SHEET 1.A) and carrying out any **restoration operations** required (SHEET 1.C), proceed as follows:

- Apply **MAPEWRAP PRIMER 1** two-component epoxy primer on the surface to be strengthened (photo A).
- While the primer is still fresh, apply an even layer 1.0-1.5 mm thick of **MAPEWRAP 11** or **MAPEWRAP 12** two-component epoxy putty with a trowel (*) (photo B).
- While the epoxy grout is still fresh, apply a layer of **MAPEWRAP 31** fluid epoxy resin to impregnate the fabric (photo C).
- Cut the **MAPEWRAP C UNI-AX** fabric to the length required with scissors.
- Lay the **MAPEWRAP C UNI-AX** on the resin and go over it with a **MAPEWRAP ROLLER** to eliminate any air bubbles (photo D).
- Apply a second layer of **MAPEWRAP 31** (photo E).
- Broadcast the resin while still fresh with dry **QUARTZ 1.2** sand (photo F).
- Wait at least 24 hours from applying the fabric and skim the surface with cementitious smoothing and levelling mortar from the **PLANITOP** range (photo G).

(*) If a longer workability time is required use **MAPEWRAP 12**.

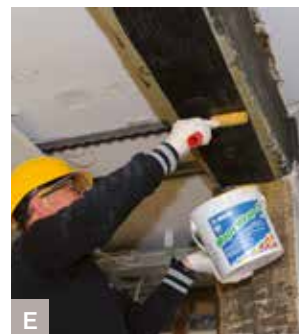
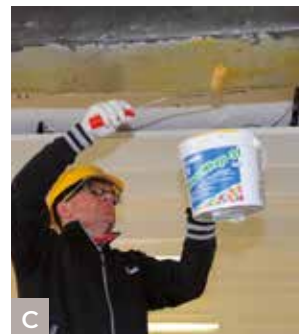

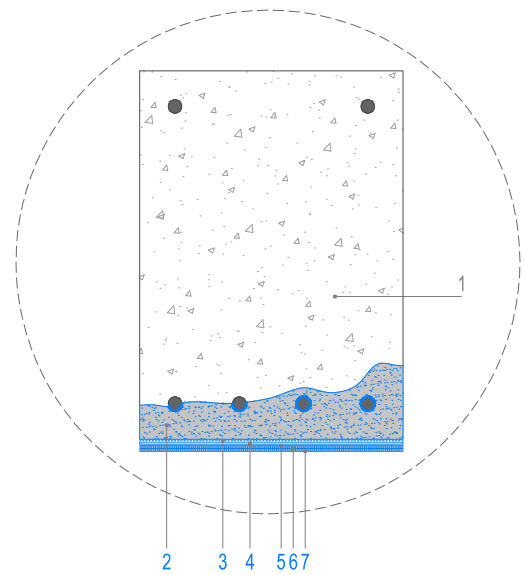
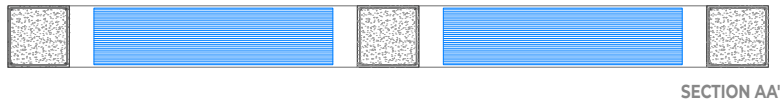
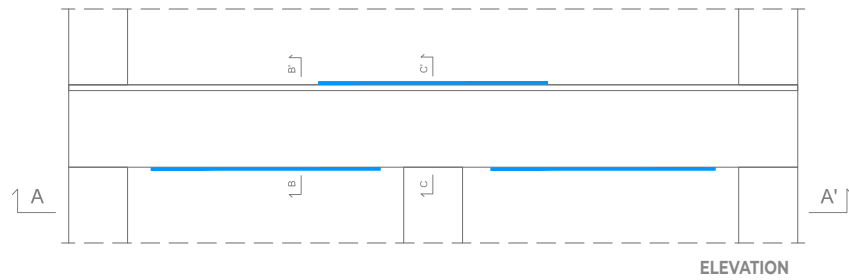

0 25 50 100 cm

↓ NOTES

1. Use the **MAPEI STRUCTURAL DESIGN** calculation tool, which is compliant with CNR DT 200 guidelines, to define the characteristics of the **MAPEWRAP UNI-AX** fabric (type of fibre, weight, modulus of elasticity, dimensions and number of layers).
2. If more than one layer of fabric is applied (we recommend applying no more than three), they must be placed directly on the layer of **MAPEWRAP 31** while still fresh.
3. **MAPEWRAP C UNI-AX SYSTEM** is covered by Technical Evaluation Certificate (CVT) according to guideline No. 220, 09/07/2015 and the following No. 293, 29/05/2019 issued by the Supreme Council of Public Works.

SCAN THE QR CODE

To download strengthening Data sheets, Technical data sheets, DWG, structural calculation software and other useful tips

or **DOWNLOAD FROM OUR WEBSITE**
www.rinforzo-strutturale.it



FLEXURAL STRENGTHENING OF BEAMS

CLADDING WITH FRP: CARBOPLATE SYSTEM PLATES

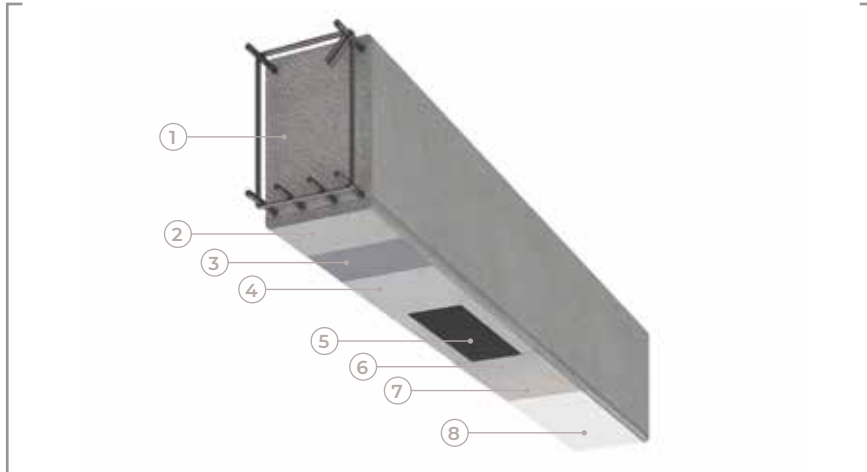

- ←
- 1 | EXISTING BEAM
 - 2 | REINTEGRATING THE SECTION
 - 3 | MAPEWRAP PRIMER 1
 - 4 | MAPEWRAP 11/12
 - 5 | CARBOPLATE
 - 6 | MAPEWRAP 11/12
 - 7 | QUARTZ 1.2
 - 8 | PLANITOP 200

APPLICATION PROCEDURE



Flexural strengthening for a beam is carried out by bonding **CARBOPLATE** carbon fibre sheets lengthways along the beam with epoxy resin.

After preparing the substrate (SHEET 1.A) and carrying out any restoration operations required (SHEET 1.C), proceed as follows:

- Apply **MAPEWRAP PRIMER 1** two-component epoxy primer on the surface to be strengthened (photo A).
- While the primer is still fresh, apply an even layer 1.0-1.5 mm thick of **MAPEWRAP 11**, **MAPEWRAP 12**, **ADESILEX PG1** or **ADESILEX PG2** two-component epoxy grout (*) with a trowel (photo B).
- Cut the **CARBOPLATE** to the length required with a hand-grinder (photo C).
- Apply **MAPEWRAP 11**, **MAPEWRAP 12**, **ADESILEX PG1** or **ADESILEX PG2** on one side of the sheet (photo D).
- Lay the **CARBOPLATE** on the resin and go over it with a **MAPEWRAP ROLLER** to eliminate any air bubbles (photo E).
- Apply another layer of **MAPEWRAP 11**, **MAPEWRAP 12**, **ADESILEX PG1** or **ADESILEX PG2** two-component thixotropic epoxy adhesive on the **CARBOPLATE** with a flat trowel.
- Broadcast the resin while still fresh with dry **QUARTZ 1.2** sand (photo G).
- Wait at least 24 hours from applying the fabric and skim the surface with cementitious smoothing and levelling mortar from the **PLANITOP** range (photo H).

(*) If a longer workability time is required use **MAPEWRAP 12** or **ADESILEX PG2**.

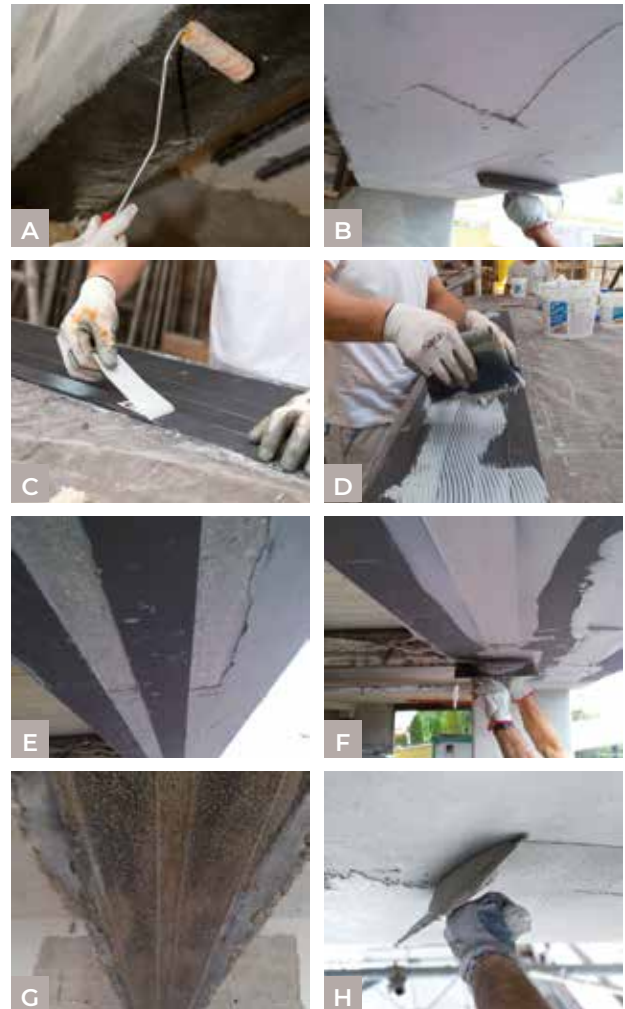

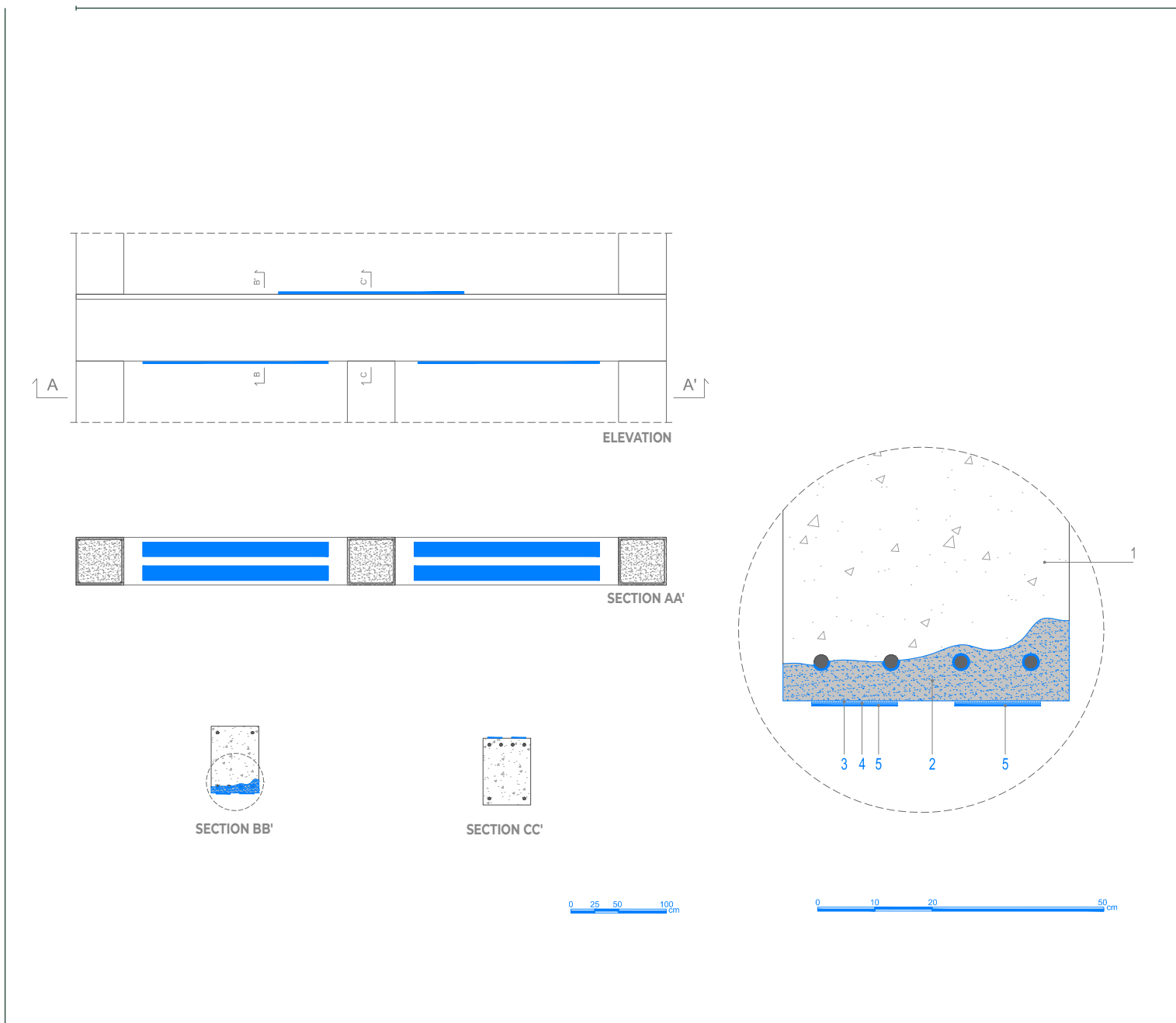

↓ NOTES

1. Use the **MAPEI STRUCTURAL DESIGN** calculation tool, which is compliant with CNR DT 200 guidelines, to define the characteristics of the **CARBOPLATE** sheets (modulus of elasticity, dimensions and number of layers).
2. If more than one layer of sheet is applied (we recommend applying no more than three), they must be placed directly on the layer of **MAPEWRAP 11** or **MAPEWRAP 12** while still fresh.
3. **CARBOPLATE SYSTEM** is covered by Technical Evaluation Certificate (CVT) according to guideline No. 220, 09/07/2015 and the following No. 293, 29/05/2019 issued by the Supreme Council of Public Works.

SCAN THE QR CODE

To download strengthening Data sheets, Technical data sheets, DWG, structural calculation software and other useful tips

or **DOWNLOAD FROM OUR WEBSITE**
www.rinforzo-strutturale.it



FLEXURAL STRENGTHENING OF BEAMS

JACKETING WITH THE HPC SYSTEM: PLANITOP HPC



APPLICATION PROCEDURE



Flexural strengthening for a RC beam is carried out by jacketing the beam with **PLANITOP HPC** microconcrete as follows:

- Roughen the surface of the beams with a power-scarifier or hydro-scarifier to leave sufficient surface roughness to ensure a good bond between the base concrete and the **PLANITOP HPC**. Surface roughness of at least 5 mm is recommended (photo A).
- Remove all loose material from the surfaces to be restored with a vacuum cleaner.
- Any steel reinforcement left exposed must be brushed and then passivated by brush-applying two coats of one-component **MAPEFER 1K** or two-component **MAPEFER** anti-corrosion cementitious mortar to prevent it corroding again.
- Apply well-sealed formwork around the beams. Wet the substrate to saturation point with water but leave the surface dry (s.s.d. condition) (photo B).
- Mix the **PLANITOP HPC** in a cement mixer.
- Pour the **PLANITOP HPC** into the formwork.
- Wait at least 72 hours before stripping the formwork (photo C).
- Once the mortar has hardened, skim the surface with cementitious smoothing and levelling mortar from the **PLANITOP** range.



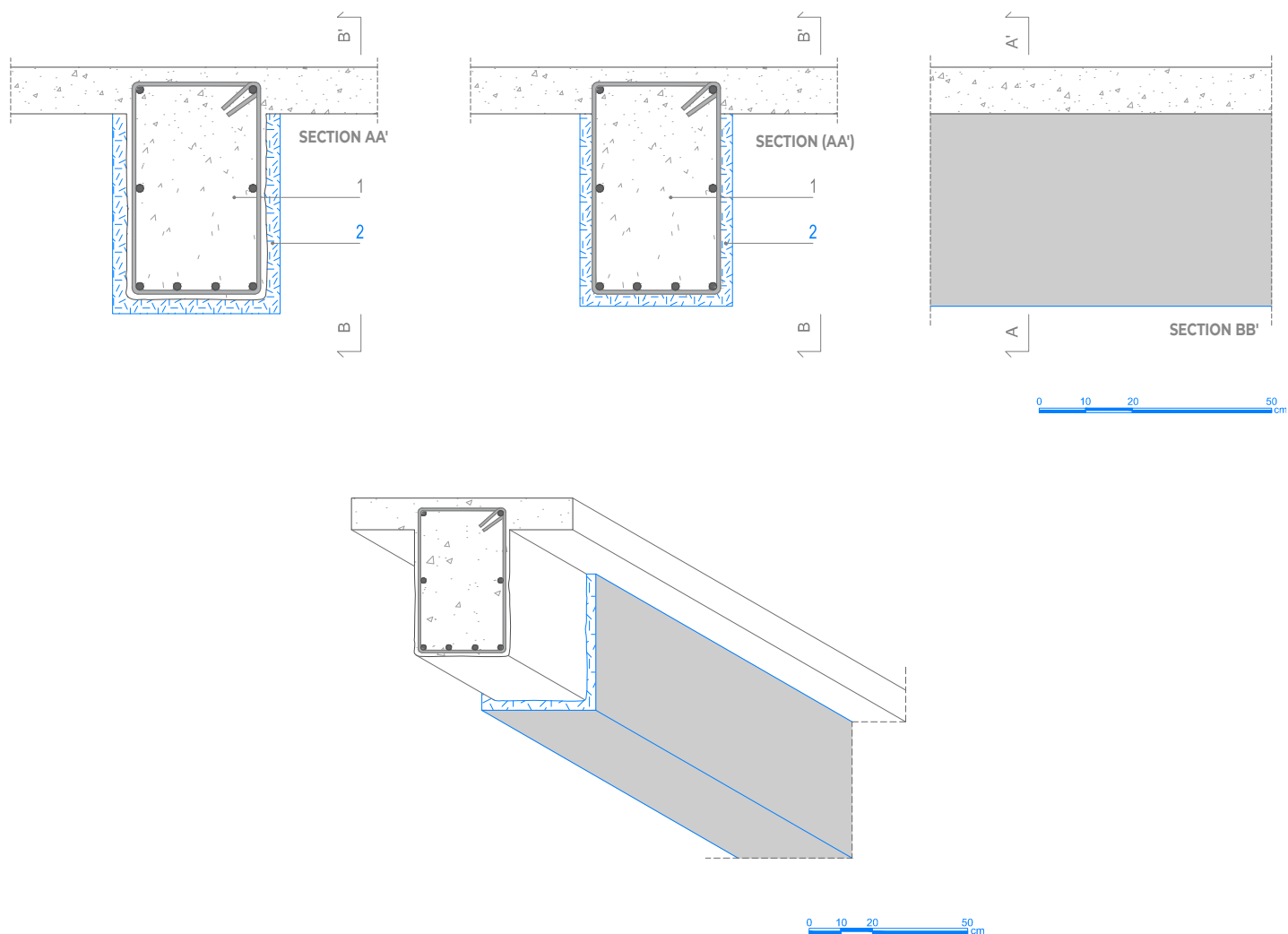

↓ NOTES

1. Use the **MAPEI STRUCTURAL DESIGN** calculation tool, which is compliant with **CNR DT 204** guidelines, to define the thickness required for the layer of **PLANITOP HPC**.
2. Strengthening work with **PLANITOP HPC** does not always require the use of traditional steel reinforcement.
3. **PLANITOP HPC** complies with the requirements of **EN 1504-3** for **R4** class structural mortar and is covered by the Technical Evaluation Certificate (CVT), D.P.C.S.LL.PP. No. 208, 09/04/2019.

SCAN THE QR CODE

To download strengthening Data sheets, Technical data sheets, DWG, structural calculation software and other useful tips

or **DOWNLOAD FROM OUR WEBSITE**
www.rinforzo-strutturale.it



SHEAR STRENGTHENING OF BEAMS CLADDING WITH FRP: MAPEWRAP SYSTEM FABRICS

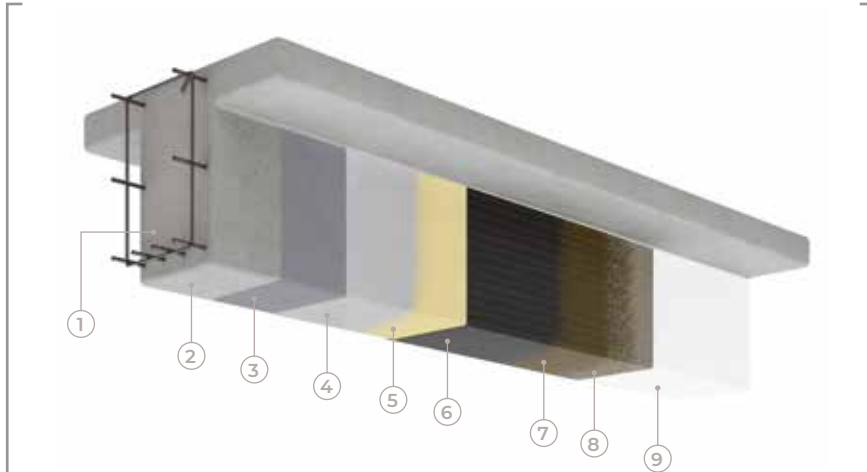

- 1 | EXISTING BEAM
- 2 | REINTEGRATING THE SECTION
- 3 | MAPEWRAP PRIMER 1
- 4 | MAPEWRAP 11/12
- 5 | MAPEWRAP 31
- 6 | MAPEWRAP C UNI-AX
- 7 | MAPEWRAP 31
- 8 | QUARTZ 1.2
- 9 | PLANITOP 200

APPLICATION PROCEDURE



Shear strengthening for a beam is carried out by bonding **MAPEWRAP** uni-directional carbon fibre fabric at right angles to the length of the beam with epoxy resin.

After **preparing the substrate** (SHEET 1.A), rounding-off the sharp edges of the beam to a radius of at least 20 mm and carrying out any **restoration operations** required (SHEET 1.C), proceed as follows.

- Apply **MAPEWRAP PRIMER 1** two-component epoxy primer on the surface to be strengthened (photo A).
 - While the primer is still fresh, apply an even layer 1.0-1.5 mm thick of **MAPEWRAP 11** or **MAPEWRAP 12** two-component epoxy putty with a trowel (*) (photo B).
 - While the epoxy grout is still fresh, apply a layer of **MAPEWRAP 31** fluid epoxy resin to impregnate the fabric (photo C).
 - Cut the **MAPEWRAP C UNI-AX** fabric to the length required with scissors.
 - Apply sheets of **MAPEWRAP C UNI-AX** side by side at right angles to the longitudinal axis of the beam to create a shape similar to an open U-clamp, or wrap them around the beam. Go over the fabric with a **MAPEWRAP ROLLER** to eliminate any air bubbles (photos D and E).
 - Apply a second layer of **MAPEWRAP 31** (photo F).
 - Broadcast the resin while still fresh with dry **QUARTZ 1.2** sand (photo G).
 - Wait at least 24 hours from applying the fabric and skim the surface with cementitious smoothing and levelling mortar from the **PLANITOP** range.
- (*) If a longer workability time is required use **MAPEWRAP 12**.



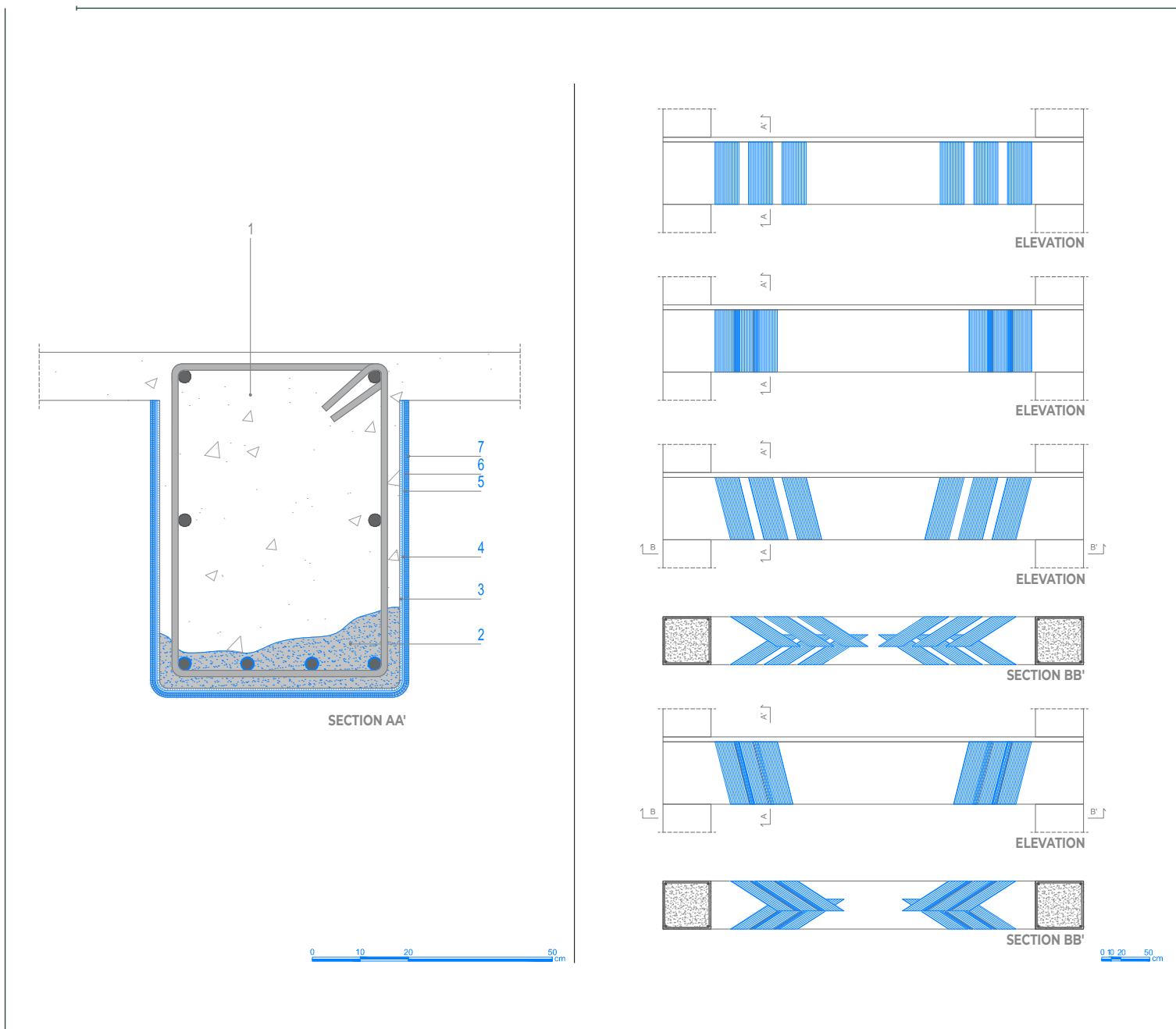

↓ NOTES

1. Use the **MAPEI STRUCTURAL DESIGN** calculation tool, which is compliant with CNR DT 200 guidelines, to define the characteristics of the **MAPEWRAP UNI-AX** fabric (type of fibre, weight, modulus of elasticity, dimensions, direction, pitch and number of layers).
2. If more than one layer of fabric is applied (we recommend applying no more than three), they must be placed directly on the layer of **MAPEWRAP 31** while still fresh.
3. **MAPEWRAP C UNI-AX SYSTEM** is covered by Technical Evaluation Certificate (CVT) according to guideline No. 220, 09/07/2015 and the following No. 293, 29/05/2019 issued by the Supreme Council of Public Works.

SCAN THE QR CODE

To download strengthening Data sheets, Technical data sheets, DWG, structural calculation software and other useful tips

or **DOWNLOAD FROM OUR WEBSITE**
www.rinforzo-strutturale.it



STRENGTHENING OF PILLARS

BINDING PILLARS TO INCREASE CONFINEMENT AND SHEAR STRENGTH WITH FRP: MAPEWRAP SYSTEM FABRICS

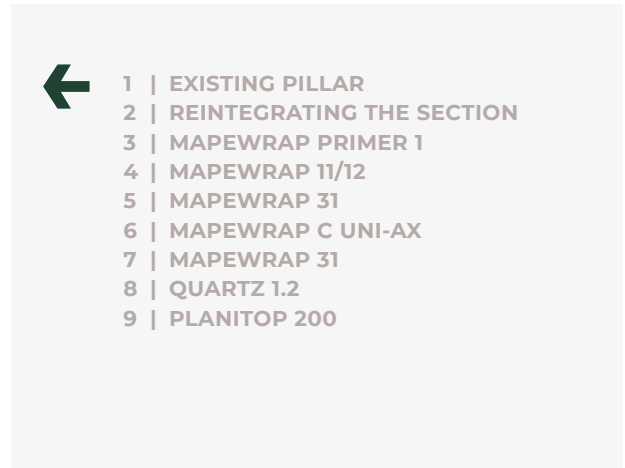
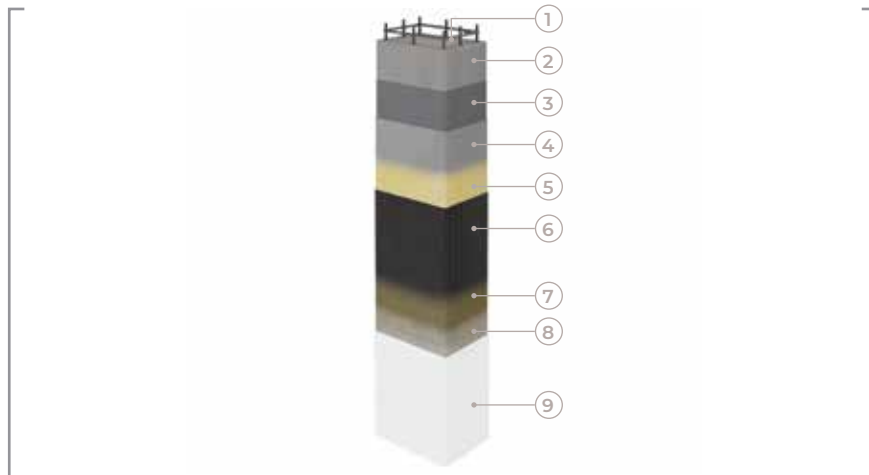

APPLICATION PROCEDURE



Strengthening for a beam (shear or confinement) is carried out by bonding **MAPEWRAP** uni-directional carbon fibre fabric at right angles to the length of the beam with epoxy resin. After preparing the substrate (SHEET 1.A), rounding-off the sharp edges of the beam to a radius of at least 20 mm and carrying out any restoration operations required (SHEET 1.C), proceed as follows.

- Apply **MAPEWRAP PRIMER 1** two-component epoxy primer on the surface to be strengthened (photo A).
 - While the primer is still fresh, apply an even layer 1.0-1.5 mm thick of **MAPEWRAP 11** or **MAPEWRAP 12** two-component epoxy putty with a trowel (*) (photo B).
 - While the epoxy grout is still fresh, apply a layer of **MAPEWRAP 31** fluid epoxy resin to impregnate the fabric (photo C).
 - Cut the **MAPEWRAP C UNI-AX** fabric to the length required with scissors.
 - Bind the pillar with sheets of **MAPEWRAP C UNI-AX** fabric at right angles to the longitudinal axis of the pillar to form a series of rings around the pillar. Go over the fabric with a **MAPEWRAP ROLLER** to eliminate any air bubbles (photo D).
 - Apply a second layer of **MAPEWRAP 31** (photo E).
 - Broadcast the resin while still fresh with dry **QUARTZ 1.2** sand (photo F).
 - Wait at least 24 hours from applying the fabric and skim the surface with cementitious smoothing and levelling mortar from the **PLANITOP** range.
- (*) If a longer workability time is required use **MAPEWRAP 12**.



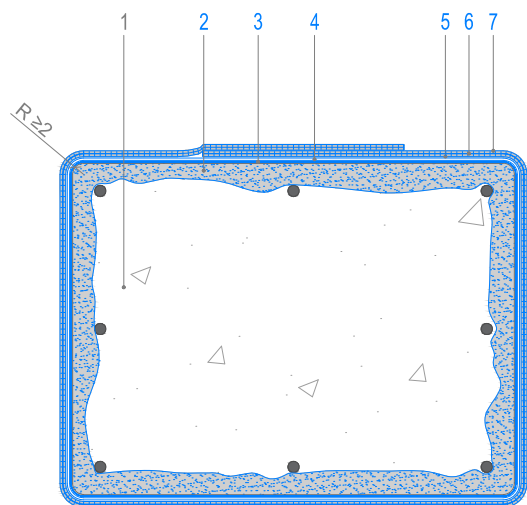

SECTION AA'

0 5 10 20 cm

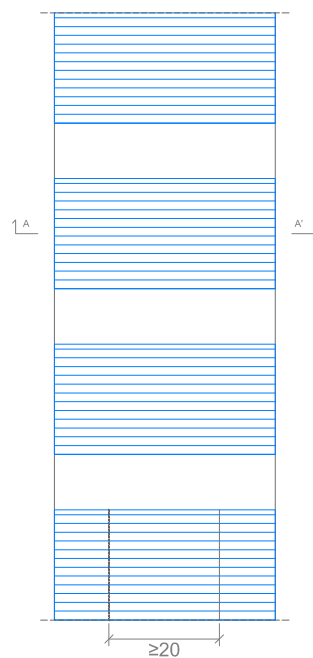

ELEVATION

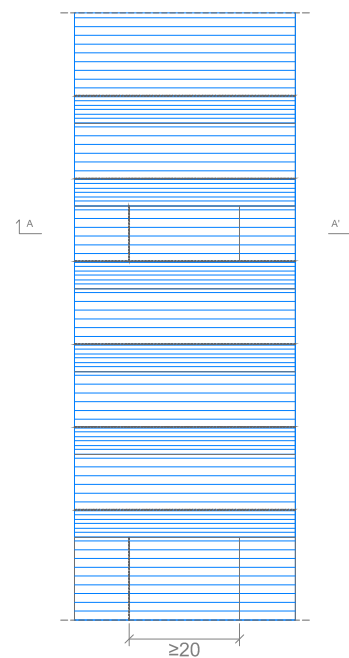

ELEVATION

0 5 10 20 cm

↓ NOTES

1. Use the **MAPEI STRUCTURAL DESIGN** calculation tool, which is compliant with CNR DT 200 guidelines, to define the characteristics of the **MAPEWRAP UNI-AX** fabric (type of fibre, weight, modulus of elasticity, dimensions, pitch and number of layers).
2. If more than one layer of fabric is applied (we recommend applying no more than three), they must be placed directly on the layer of **MAPEWRAP 31** while still fresh.
3. **MAPEWRAP C UNI-AX SYSTEM** is covered by Technical Evaluation Certificate (CVT) according to guideline No. 220, 09/07/2015 and the following No. 293, 29/05/2019 issued by the Supreme Council of Public Works.

SCAN THE QR CODE

To download strengthening Data sheets, Technical data sheets, DWG, structural calculation software and other useful tips

or **DOWNLOAD FROM OUR WEBSITE**
www.rinforzo-strutturale.it



STRENGTHENING OF PILLARS

COMBINED COMPRESSIVE AND BENDING STRENGTHENING BY CLADDING WITH FRP: MAPEWRAP SYSTEM FABRICS

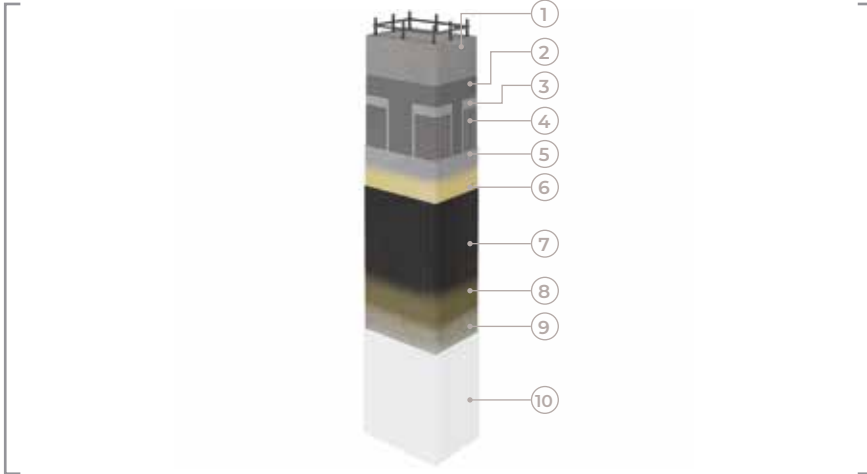

- ←
- 1 | EXISTING PILLAR
 - 2 | MAPEWRAP PRIMER 1
 - 3 | MAPEWRAP 11/12
 - 4 | MAPEWRAP S FABRIC
 - 5 | MAPEWRAP 11/12
 - 6 | MAPEWRAP 31
 - 7 | MAPEWRAP C UNI-AX
 - 8 | MAPEWRAP 31
 - 9 | QUARTZ 1.2
 - 10 | PLANITOP 200

APPLICATION PROCEDURE



Combined compressive and bending strengthening for beams is carried out by bonding **MAPEWRAP** uni-directional carbon fibre fabric lengthways and at right angles to the longitudinal axis of the beam with epoxy resin. After **preparing the substrate** (SHEET 1.A), rounding-off the sharp edges of the beam to a radius of at least 20 mm and carrying out any **restoration operations** required (SHEET 1.C), proceed as follows.

- Drill a series of holes in the base of the pillar below foundation level (*) (photo A).
- Apply **MAPEWRAP PRIMER 1** two-component epoxy primer on the surface to be strengthened (photo B).
- While the primer is still fresh, apply an even layer 1.0-1.5 mm thick of **MAPEWRAP 11** or **MAPEWRAP 12** two-component epoxy putty with a trowel (**) (photo C).
- Apply sheets of **MAPEWRAP S FABRIC** along the longitudinal axis of the pillar, starting from the bottom. This operation may be extended to cover the whole length of the pillar (photo D).
- Apply a second layer of **MAPEWRAP 11** or **MAPEWRAP 12** (*) two-component epoxy grout (photo E).
- Fill the holes drilled in the base of the pillar with **MAPEFIX EP 385** epoxy chemical anchor to graft in connectors made from pieces of **MAPEWRAP S FABRIC** (photo F).
- Insert the **MAPEWRAP S FABRIC** connectors in the holes (photo G).
- Splay out the ends of the connectors and lay them on the fabric applied previously. The connectors must go right down to the bottom of the holes drilled in the pillar and then continue along the pillar for at least 70 cm (photo H).
- Impregnate the ends of the connectors with **MAPEWRAP 11** (photo I).
- While the epoxy grout is still fresh, apply a layer of **MAPEWRAP 31** fluid epoxy resin to impregnate the fabric (photo J).
- Cut the **MAPEWRAP C UNI-AX** fabric to the length required with scissors.
- While the layer of **MAPEWRAP 31** resin is still fresh, wrap confinement strips of **MAPEWRAP C UNI-AX** unidirectional carbon fibre fabric to form rings around



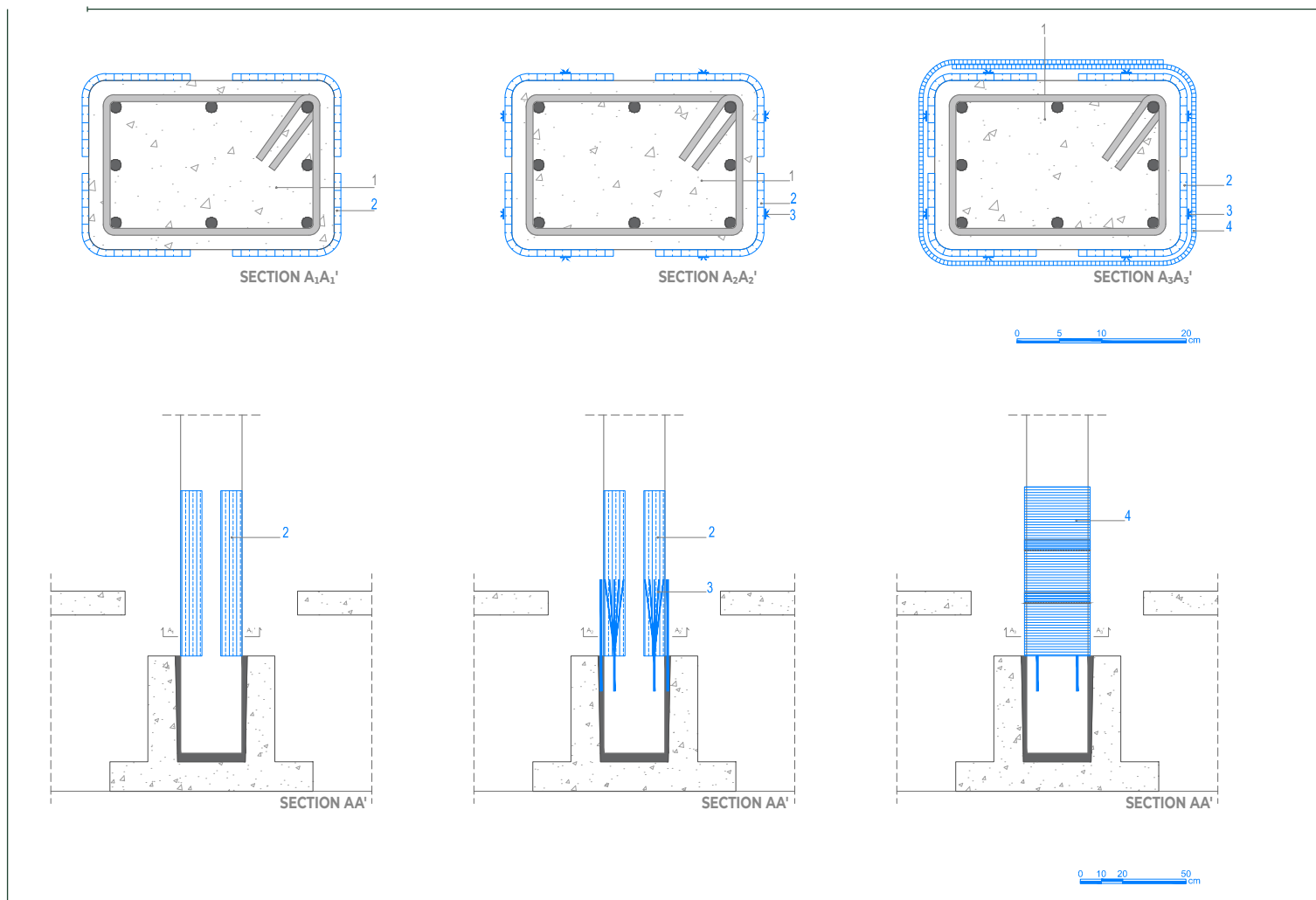

the pillar at right angles to the longitudinal axis of the pillar. Go over the fabric with a **MAPEWRAP ROLLER** to eliminate any air bubbles. The sheets and strips of fabric must be applied so that there is always an overlap of 20 cm in a horizontal direction and 5 cm in a vertical direction (photo K).

- Apply another layer of **MAPEWRAP 31** (photo L).
- Broadcast the resin while still fresh with dry **QUARTZ 1.2** sand (photo M).

→ Wait at least 24 hours from applying the fabric and skim the surface with cementitious smoothing and levelling mortar from the **PLANITOP** range (photo N).

(*) The number of holes required must be calculated

(**) If a longer workability time is required use **MAPEWRAP 12**.

↓ NOTES

1. Use the **MAPEI STRUCTURAL DESIGN** calculation tool, which is compliant with CNR DT 200 guidelines, to define the characteristics of the **MAPEWRAP UNI-AX** fabric (type of fibre, weight, modulus of elasticity, dimensions, pitch and number of layers).
2. As an alternative to **MAPEWRAP S FABRIC** it is possible to use **MAPEWRAP C UNI-AX** or **CARBOPLATE** sheets.
3. **MAPEWRAP C UNI-AX SYSTEM** is covered by Technical Evaluation Certificate (CVT) according to guideline No. 220, 09/07/2015 and the following No. 293, 29/05/2019 issued by the Supreme Council of Public Works.

SCAN THE QR CODE

To download strengthening Data sheets, Technical data sheets, DWG, structural calculation software and other useful tips

or **DOWNLOAD FROM OUR WEBSITE**
www.rinforzo-strutturale.it



STRENGTHENING OF PILLARS

JACKETING WITH THE HPC SYSTEM: PLANITOP HPC

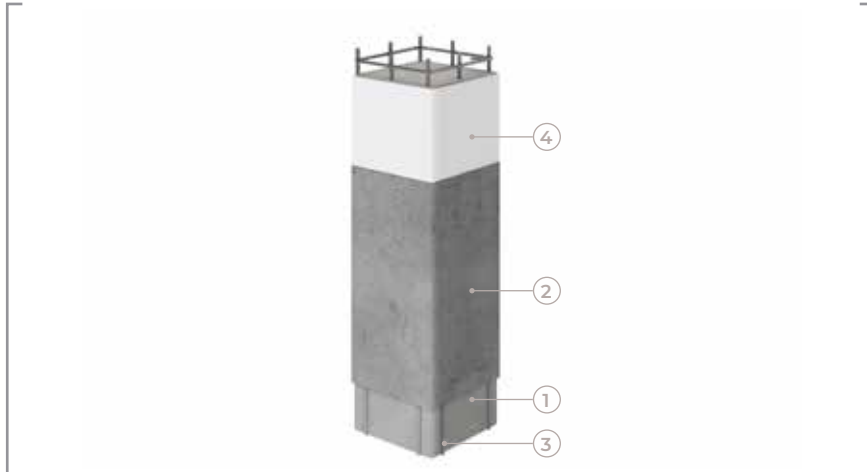

APPLICATION PROCEDURE



Strengthening for RC pillars may be carried out by jacketing them with **PLANITOP HPC** microconcrete as follows:

- Roughen the surface of the pillars with a power-scarifier or hydro-scarifier to leave sufficient surface roughness to ensure a good bond between the base concrete and the fibre-reinforced concrete. Surface roughness of at least 5 mm is recommended (photo A). Remove all loose material from the surfaces to be restored with a vacuum cleaner. Any steel reinforcement left exposed must be brushed and then passivated by brush-applying two coats of one-component **MAPEFER 1K** or two-component **MAPEFER** anti-corrosion cementitious mortar to prevent it corroding again.
- Apply well-sealed formwork around the pillars and saturate the substrate with water but leave a dry surface (s.s.d. condition) (photo B).
- Mix the **PLANITOP HPC** in a cement mixer.
- Pour the **PLANITOP HPC** into the formwork.
- Wait at least 72 hours before stripping the formwork (photo C).
- Once the mortar has hardened, skim the surface with cementitious smoothing and levelling mortar from the **PLANITOP** range.



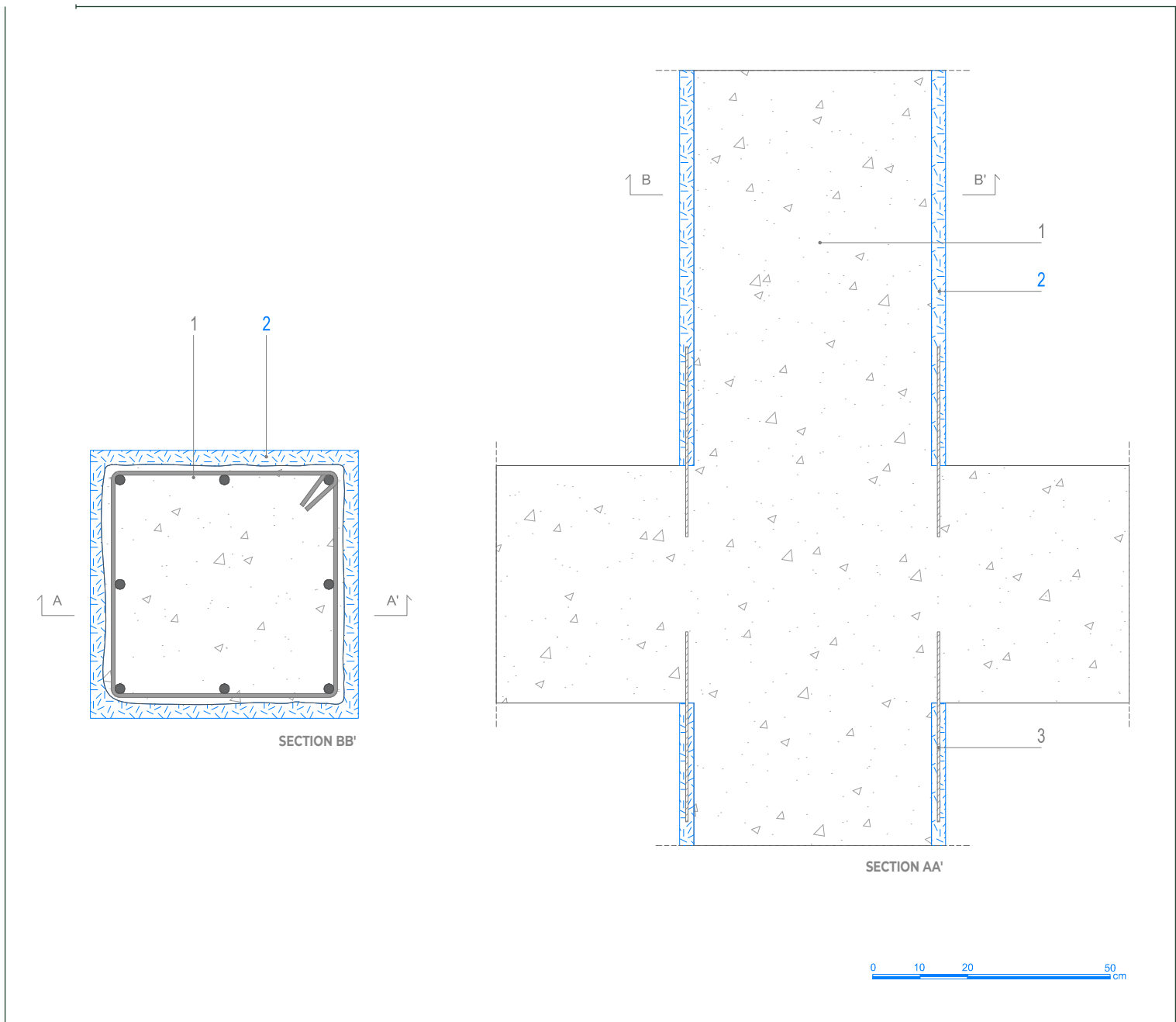

↓ NOTES

1. Use the **MAPEI STRUCTURAL DESIGN** calculation tool, which is compliant with CNR DT 204 guidelines, to define the thickness required for the layer of **PLANITOP HPC**.
2. Strengthening work with **PLANITOP HPC** does not always require the use of traditional steel reinforcement.
3. **PLANITOP HPC** complies with the requirements of EN 1504-3 for R4 class structural mortar and is covered by the Technical Evaluation Certificate (CVT), D.P.C.S.LL.PP. No. 208, 09/04/2019.

SCAN THE QR CODE

To download strengthening Data sheets, Technical data sheets, DWG, structural calculation software and other useful tips

or **DOWNLOAD FROM OUR WEBSITE**
www.rinforzo-strutturale.it



STRENGTHENING OF BEAM-PILLAR CORNER JOINTS CLADDING WITH FRP: MAPEWRAP SYSTEM FABRICS

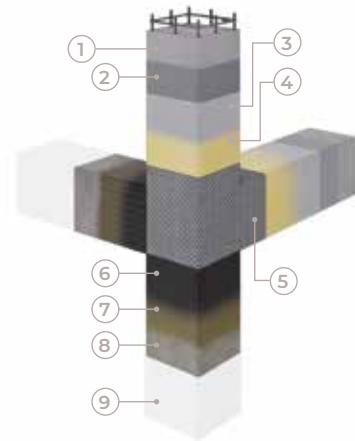

- 1 | EXISTING RC STRUCTURE
- 2 | MAPEWRAP PRIMER 1
- 3 | MAPEWRAP 11/12
- 4 | MAPEWRAP 31
- 5 | MAPEWRAP C QUADRI-AX
- 6 | MAPEWRAP C UNI-AX
- 7 | MAPEWRAP 31
- 8 | QUARTZ 1.2
- 9 | PLANITOP 200

APPLICATION PROCEDURE



Shear strengthening for RC beam-pillar joints is carried out by bonding **MAPEWRAP** uni-directional carbon fibre fabric with epoxy resin, depending on the configuration of the joint.

After preparing the substrate (SHEET 1.A), rounding-off the sharp edges of the pillars and beams forming the joints to a radius of at least 20 mm, removing all the dust and carrying out any restoration operations required (SHEET 1.C), proceed as follows:

- Apply **MAPEWRAP PRIMER 1** two-component epoxy primer on the surface to be strengthened (photos A and B).
- While the primer is still fresh, apply an even layer 1.0-1.5 mm thick of **MAPEWRAP 11** or **MAPEWRAP 12** two-component epoxy putty with a trowel (*) (photos C and D).
- While the epoxy putty is still fresh, apply a layer of **MAPEWRAP 31** fluid epoxy resin to impregnate the fabric (photo E).
- Cut the **MAPEWRAP C** fabric to the length required with scissors.
- Apply angular pieces of **MAPEWRAP C UNI-AX** unidirectional high-strength carbon fibre fabric (or **MAPEWRAP C QUADRI-AX** quadridirectional fabric) around the joint between the column and the beam and impregnate it with **MAPEWRAP 31** (photo F).
- Lay strips of **MAPEWRAP C QUADRI-AX** on the central panel of the joint (photo G).
- Apply a second layer of **MAPEWRAP 31** on the fabric applied around the joint (photo H).
- Bind the end parts of the pillar forming the joint with **MAPEWRAP C UNI-AX** unidirectional carbon fibre fabric. Apply the fabric so that it forms a series of rings around the pillar and overlap each strip used to form the rings by 5 cm on the vertical sides and 20 cm on the horizontal sides (photo I).
- Apply a second layer of **MAPEWRAP 31** on the fabric (photo J).



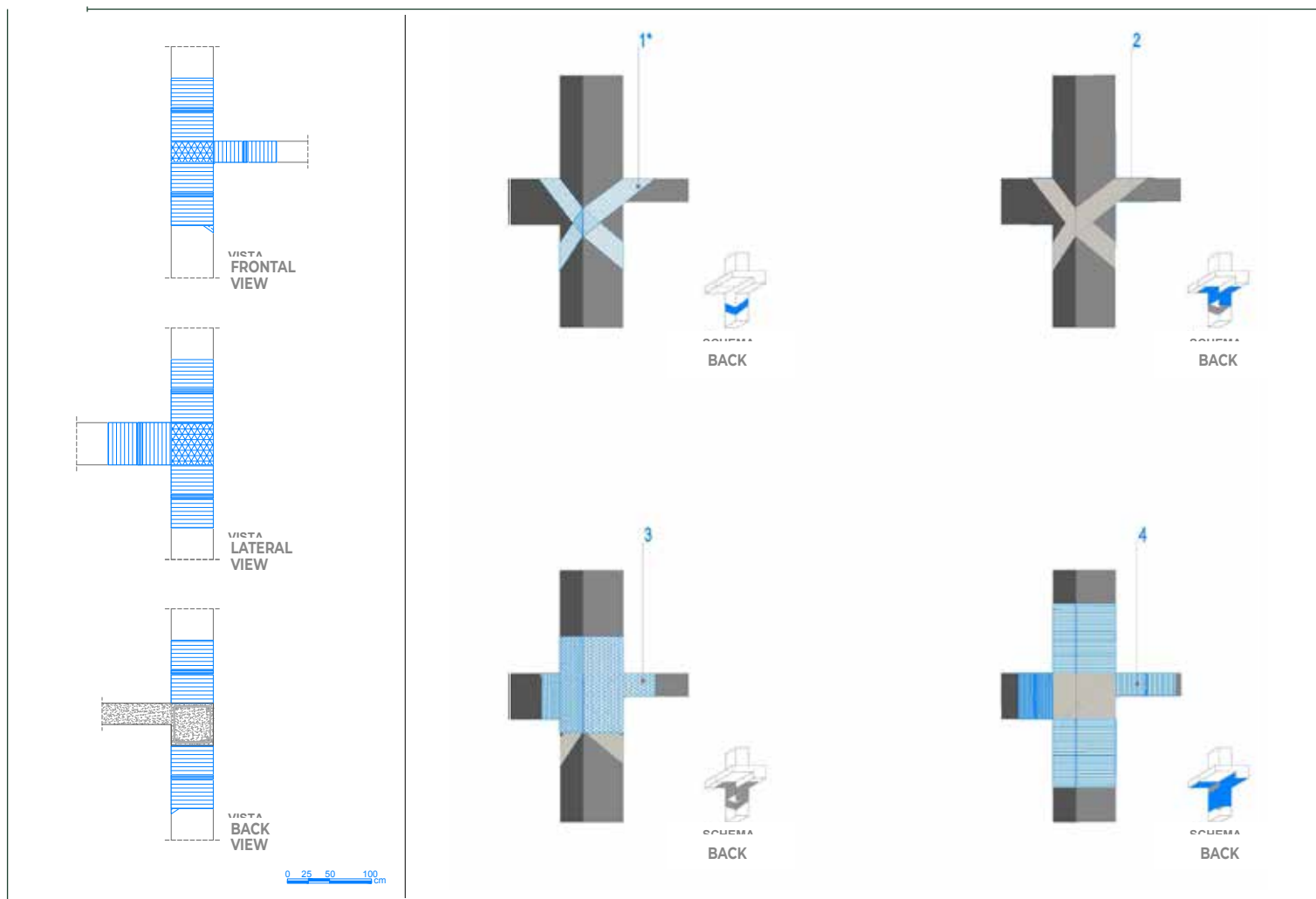

→ Bind the end parts of the beams forming the joint with **MAPEWRAP C UNI-AX** to create a shape similar to an open U-clamp (photo K).

→ Apply a second layer of **MAPEWRAP 31** on the fabric (photo L).

→ Broadcast the resin while still fresh with dry **QUARTZ 1.2** sand (photo M).

→ Wait at least 24 hours from applying the fabric and skim the surface with cementitious smoothing and levelling mortar from the **PLANITOP** range.

↓ NOTES

1. Use the **MAPEI STRUCTURAL DESIGN** calculation tool, which is compliant with **CNR DT 200** guidelines, to define the characteristics of the **MAPEWRAP UNI-AX** fabric (type of fibre, weight, modulus of elasticity, dimensions, direction, pitch and number of layers).

2. If more than one layer of fabric is applied (we recommend applying no more than three), they must be placed directly on the layer of **MAPEWRAP 31** while still fresh.

3. Before applying **MAPEWRAP C QUADRI-AX** on the joint, it is possible to apply a double strip of **MAPEWRAP C UNI-AX** around the beam-pillar intersection. Apply the fabric at an angle of around 45° so that it can absorb any potential hammering phenomenon caused by buffer walls during an earthquake.

4. **MAPEWRAP C UNI-AX SYSTEM** is covered by Technical Evaluation Certificate (CVT) according to guideline No. 220, 09/07/2015 and the following No. 293, 29/05/2019 issued by the Supreme Council of Public Works.

SCAN THE QR CODE

To download strengthening Data sheets, Technical data sheets, DWG, structural calculation software and other useful tips

or **DOWNLOAD FROM OUR WEBSITE**
www.rinforzo-strutturale.it



STRENGTHENING OF BEAM-PILLAR CORNER JOINTS

JACKETING WITH THE HPC SYSTEM: PLANITOP HPC

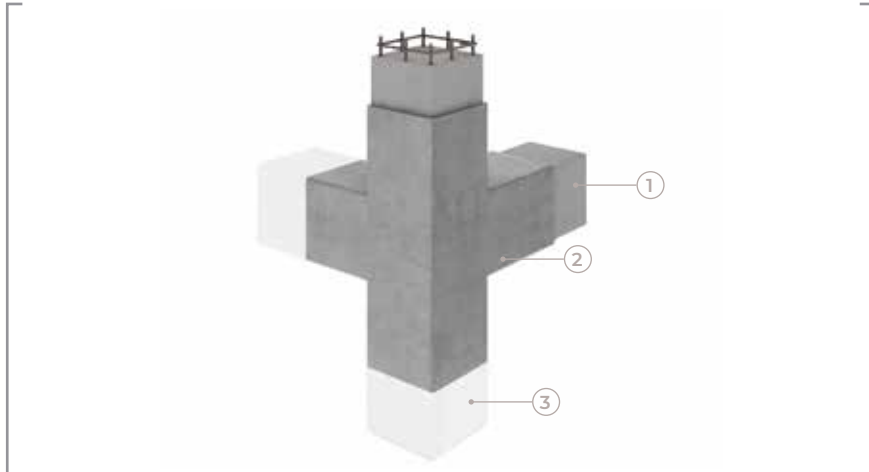

APPLICATION PROCEDURE



Strengthening for RC beam-pillar joints is carried out by jacketing them with **PLANITOP HPC** microconcrete as follows:

- Roughen the surface of the pillars with a power-scarifier or hydro-scarifier to leave sufficient surface roughness to ensure a good bond between the base concrete and the fibre-reinforced concrete. Surface roughness of at least 5 mm is recommended (photo A).
Remove all loose material from the surfaces to be restored with a vacuum cleaner. Any steel reinforcement left exposed must be brushed and then passivated by brush-applying two coats of one-component **MAPEFER 1K** or two-component **MAPEFER** anti-corrosion cementitious mortar to prevent it corroding again.
- Apply well-sealed formwork around the beam-pillar joints. Wet the substrate to saturation point with water but leave the surface dry (s.s.d. condition) (photo B).
- Mix **PLANITOP HPC** in a cement mixer.
- Pour **PLANITOP HPC** into the formwork.
- Wait at least 72 hours before stripping the formwork (photo C).
- Once the mortar has hardened, skim the surface with cementitious smoothing and levelling mortar from the **PLANITOP** range.



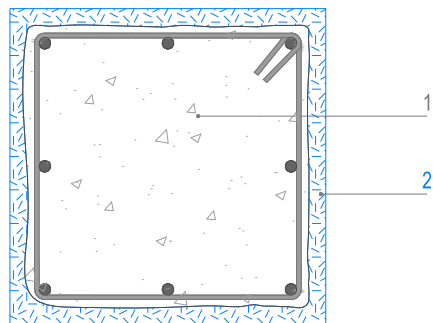

SECTION AA'

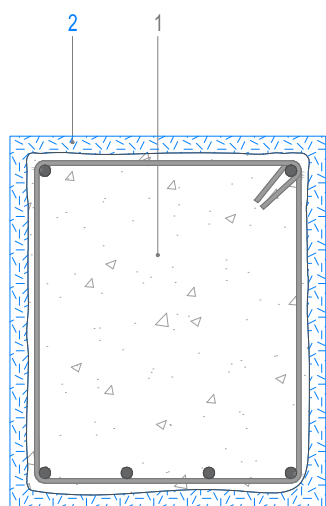

SECTION BB'

0 10 20 50 cm

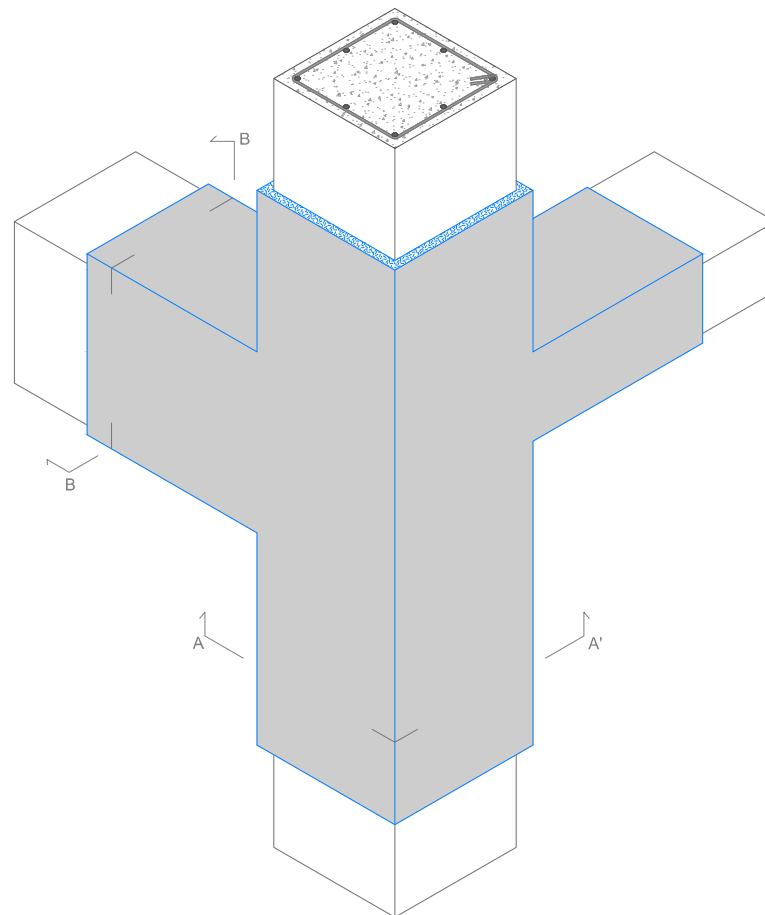
AXONOMETRIC
PROJECTION

0 10 20 50 cm

↓ NOTES

1. Strengthening work with **PLANITOP HPC** does not always require the use of traditional steel reinforcement.
2. **PLANITOP HPC** complies with the requirements of EN 1504-3 for R4 class structural mortar and is covered by the Technical Evaluation Certificate (CVT), D.P.C.S.LL.PP. No. 208, 09/04/2019.

SCAN THE QR CODE

To download strengthening Data sheets, Technical data sheets, DWG, structural calculation software and other useful tips

or **DOWNLOAD FROM OUR WEBSITE**
www.rinforzo-strutturale.it



STRENGTHENING OF BEAM-PILLAR PERIMETER JOINTS CLADDING WITH FRP: MAPEWRAP SYSTEM FABRICS

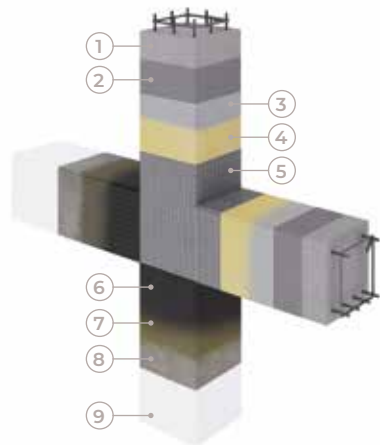

- 1 | EXISTING RC STRUCTURE
- 2 | MAPEWRAP PRIMER 1
- 3 | MAPEWRAP 11/12
- 4 | MAPEWRAP 31
- 5 | MAPEWRAP C QUADRI-AX
- 6 | MAPEWRAP C UNI-AX
- 7 | MAPEWRAP 31
- 8 | QUARTZ 1.2
- 9 | PLANITOP 200

APPLICATION PROCEDURE



Shear strengthening for RC beam-pillar joints is carried out by bonding **MAPEWRAP** uni-directional carbon fibre fabric with epoxy resin, depending on the configuration of the joint. After preparing the substrate (SHEET 1.A), rounding-off the sharp edges of the pillars and beams forming the joints to a radius of at least 20 mm, removing all the dust and carrying out any restoration operations required (SHEET 1.C), proceed as follows:

- Apply **MAPEWRAP PRIMER 1** two-component epoxy primer on the surface to be strengthened (photo A).
- While the primer is still fresh, apply an even layer 1.0-1.5 mm thick of **MAPEWRAP 11** or **MAPEWRAP 12** two-component epoxy putty with a trowel (*) (photo B).
- While the epoxy grout is still fresh, apply a layer of **MAPEWRAP 31** fluid epoxy resin to impregnate the fabric (photo C).
- Cut the **MAPEWRAP C** fabric to the length required with scissors.
- Apply angular pieces of **MAPEWRAP C UNI-AX** unidirectional high-strength carbon fibre fabric (or **MAPEWRAP C QUADRI-AX** quadridirectional fabric) around the joint between the column and the beam and impregnate it with **MAPEWRAP 31** (photo D).
- Lay strips of **MAPEWRAP C QUADRI-AX** on the central panel of the joint (photo E).
- Apply a second layer of **MAPEWRAP 31** on the fabric applied around the joint (photo F).
- Bind the end parts of the pillar forming the joint with **MAPEWRAP C UNI-AX** unidirectional carbon fibre fabric. Apply the fabric to form rings around the pillar and overlap each strip used to form the rings by 5 cm on the vertical sides and 20 cm on the horizontal sides (photo G).
- Apply a second layer of **MAPEWRAP 31** on the fabric applied around the joint (photo H).
- Bind the end parts of the beams forming the joint with **MAPEWRAP C UNI-AX** to create a shape similar to an open U-clamp (photo I).



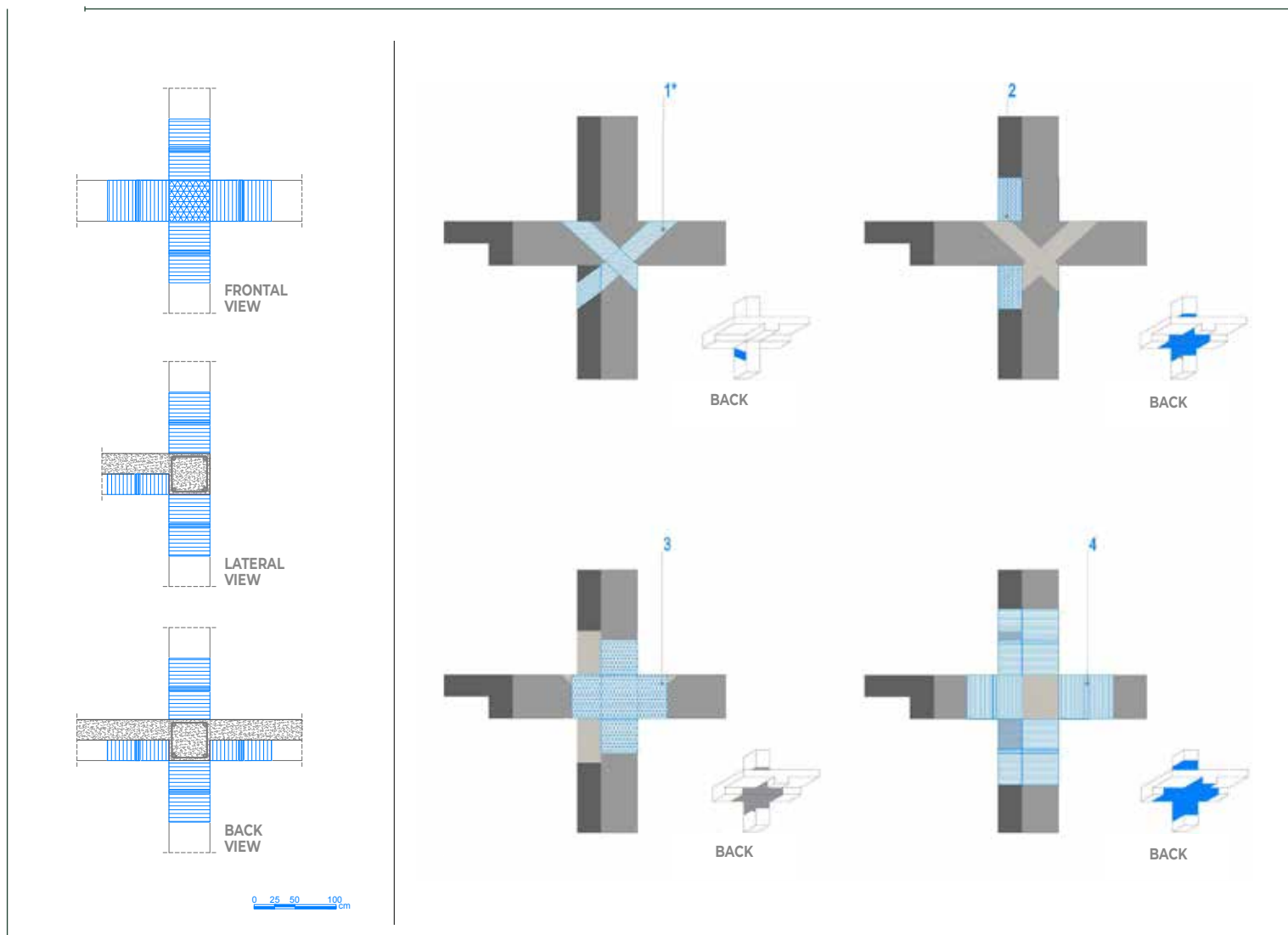

- Apply a second layer of **MAPEWRAP 31** on the fabric (photo J).
- Broadcast the resin while still fresh with dry **QUARTZ 1.2** sand (photo K).

- Wait at least 24 hours from applying the fabric and skim the surface with cementitious smoothing and levelling mortar from the **PLANITOP** range.

↓ NOTES

1. Use the **MAPEI STRUCTURAL DESIGN** calculation tool, which is compliant with **CNR DT 200** guidelines, to define the characteristics of the **MAPEWRAP UNI-AX** fabric (type of fibre, weight, modulus of elasticity, dimensions, direction, pitch and number of layers).
2. If more than one layer of fabric is applied (we recommend applying no more than three), they must be placed directly on the layer of **MAPEWRAP 31** while still fresh.
3. Before applying **MAPEWRAP C QUADRI-AX** on the joint, it is possible to apply a double strip of **MAPEWRAP C UNI-AX** around the beam-pillar intersection. Apply the fabric at an angle of around 45° so that it can absorb any potential hammering phenomenon caused by buffer walls during an earthquake.
4. **MAPEWRAP C UNI-AX SYSTEM** and **MAPEWRAP C QUADRI-AX SYSTEM** are covered by Technical Evaluation Certificate (CVT) according to guideline No. 220, 09/07/2015 and the following No. 293, 29/05/2019 issued by the Supreme Council of Public Works.

SCAN THE QR CODE

To download strengthening Data sheets, Technical data sheets, DWG, structural calculation software and other useful tips

or **DOWNLOAD FROM OUR WEBSITE**
www.rinforzo-strutturale.it



STRENGTHENING OF BEAM-PILLAR PERIMETER JOINTS

JACKETING WITH THE HPC SYSTEM: PLANITOP HPC

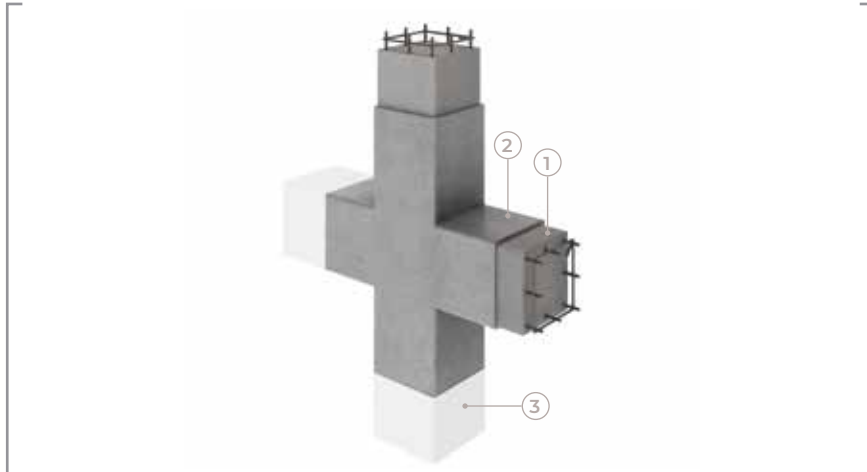

APPLICATION PROCEDURE



Strengthening for RC beam-pillar joints is carried out by jacketing them with **PLANITOP HPC** microconcrete as follows:

- Roughen the surface of the beam-pillar joints with a power-scarifier or hydro-scarifier to leave sufficient surface roughness to ensure a good bond between the base concrete and the fibre-reinforced concrete. Surface roughness of at least 5 mm is recommended (photo A).
- Remove all loose material from the surfaces to be restored with a vacuum cleaner. Any steel reinforcement left exposed must be brushed and then passivated by brush-applying two coats of one-component **MAPEFER 1K** or two-component **MAPEFER** anti-corrosion cementitious mortar to prevent it corroding again.
- Apply well-sealed formwork around the beam-pillar joints. Wet the substrate to saturation point with water but leave the surface dry (s.s.d. condition) (photo B).
- Mix **PLANITOP HPC** in a cement mixer.
- Pour **PLANITOP HPC** into the formwork.
- Wait at least 72 hours before stripping the formwork (photo C).
- Once the mortar has hardened, skim the surface with cementitious smoothing and levelling mortar from the **PLANITOP** range.



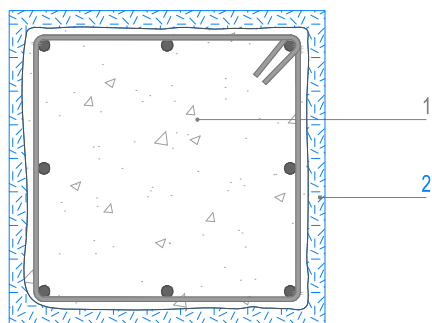

SECTION AA'

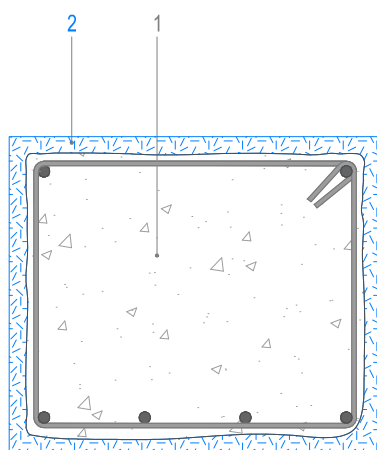

SECTION BB'

0 10 20 50 cm

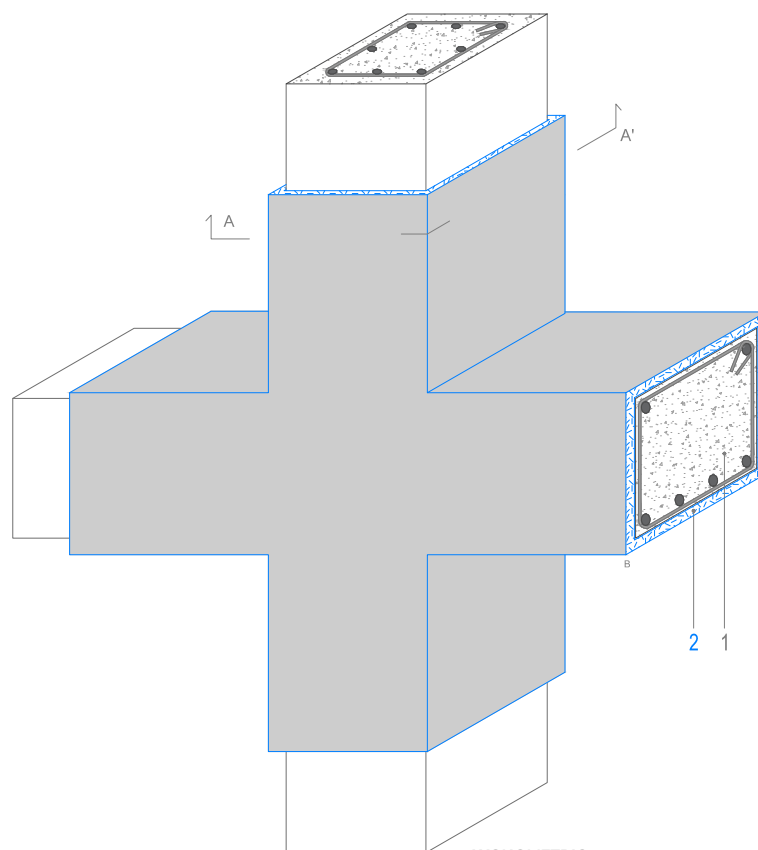
AXONOMETRIC
PROJECTION

0 10 20 50 cm

↓ NOTES

1. Strengthening work with **PLANITOP HPC** does not always require the use of traditional steel reinforcement.
2. **PLANITOP HPC** complies with the requirements of EN 1504-3 for R4 class structural mortar and is covered by the Technical Evaluation Certificate (CVT), D.P.C.S.LL.PP. No. 208, 09/04/2019.

SCAN THE QR CODE

To download strengthening Data sheets, Technical data sheets, DWG, structural calculation software and other useful tips

or **DOWNLOAD FROM OUR WEBSITE**
www.rinforzo-strutturale.it



STRENGTHENING OF FLOOR SLABS WITH STRUCTURAL SCREED

STRENGTHENING LEVEL FLOOR SLABS WITH A LOW-THICKNESS STRUCTURAL SCREED USING THE HPC SYSTEM: PLANITOP HPC FLOOR

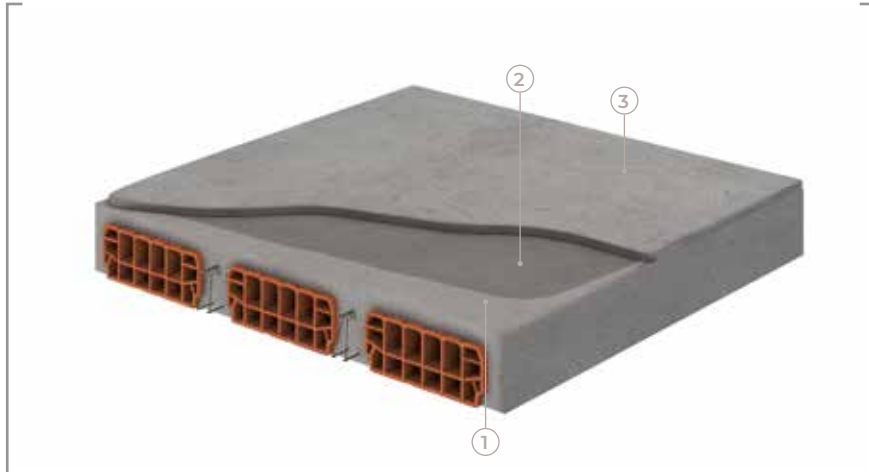

- 1 | EXISTING BRICK-CONCRETE FLOOR SLAB
- 2 | PRIMER 3296
- 3 | PLANITOP HPC FLOOR
- 4 | CONNECTORS AROUND THE SIDES FASTENED WITH MAPEFIX EP 385-585

APPLICATION PROCEDURE



Strengthening the extrados of a floor slab may be carried out by integrating it with a structural screed made from **PLANITOP HPC FLOOR** microconcrete. Prepare the substrate by stripping the floor down to the level of the existing screed and roughen the screed with power tools. The surface roughness must be at least 5 mm to ensure a good bond between the existing screed and the **PLANITOP HPC FLOOR**.

→ Insert a series of dolly bars made from B450C rebar into holes drilled into the walls or beams around the floor slab parallel to the floor joists and anchor the rebars in place with **MAPEFIX EP 385** epoxy chemical anchor or **MAPEFIX VE SF** vinyl ester chemical anchor. Go over the surface with a vacuum cleaner to remove all traces of loose material (photo A).

→ Consolidate the extrados of the existing screed with **PRIMER 3296** diluted 1:1 with water (photo B).

→ At least 4 hours after applying the primer prepare the **PLANITOP HPC FLOOR** in a cement mixer (photo C).

→ Pour the **PLANITOP HPC FLOOR** onto the floor to form a layer around 2 cm thick (1) (photos D, E and F).



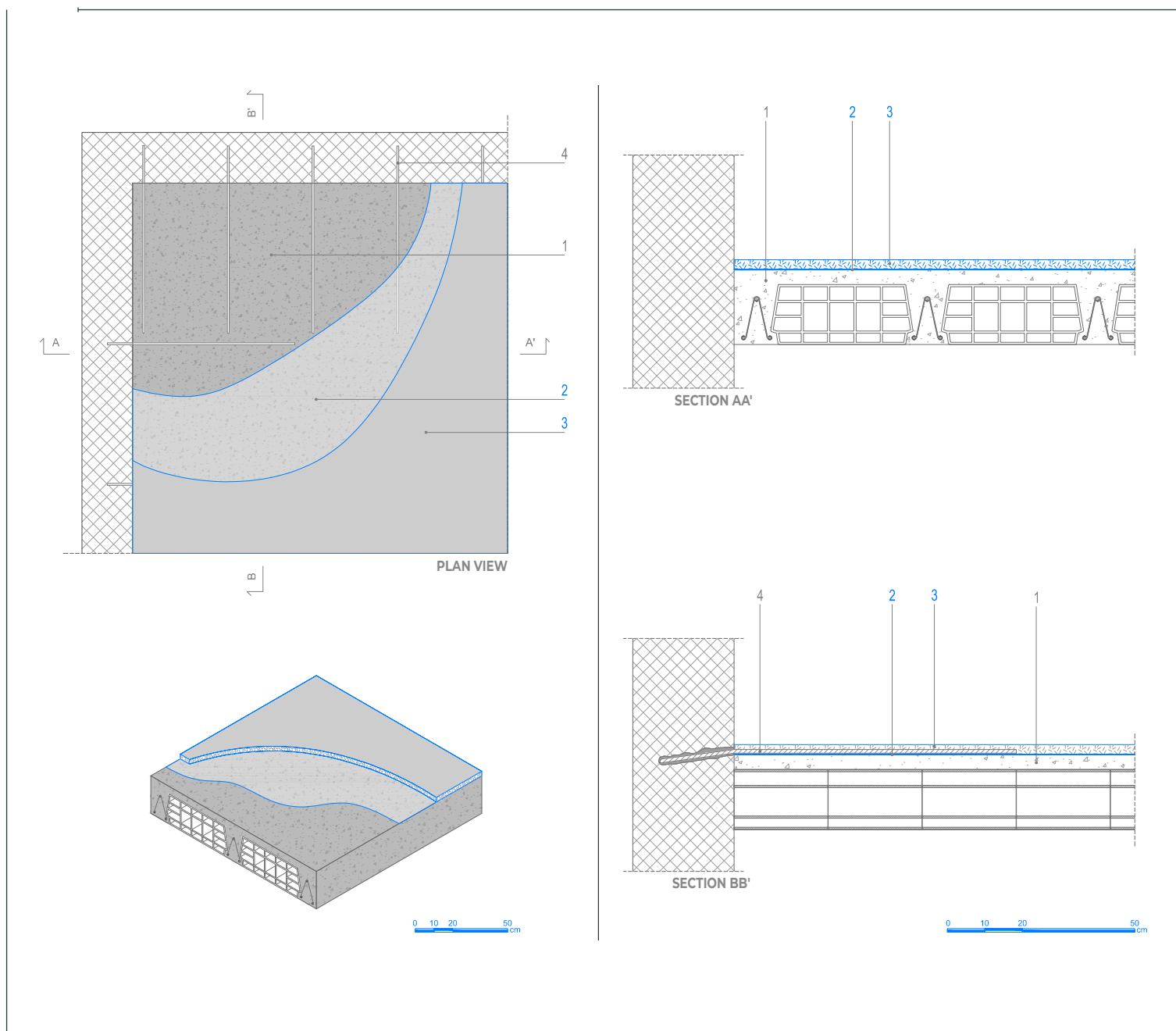

↓ NOTES

1. Use the **MAPEI STRUCTURAL DESIGN** calculation tool, which is compliant with CNR DT 204 guidelines, to define the thickness required for the layer of **PLANITOP HPC**.
2. If a second pour of **PLANITOP HPC FLOOR** needs to be carried out, it is good practice to apply **EPORIP** or insert pieces of rebar.
3. Strengthening work using **PLANITOP HPC FLOOR** does not require the use of connectors or electro-welded mesh.

SCAN THE QR CODE

To download strengthening Data sheets, Technical data sheets, DWG, structural calculation software and other useful tips

or **DOWNLOAD FROM OUR WEBSITE**
www.rinforzo-strutturale.it



STRENGTHENING OF FLOOR SLABS WITH STRUCTURAL SCREED

STRENGTHENING SLOPING FLOOR SLABS WITH A LOW-THICKNESS STRUCTURAL SCREED USING THE HPC SYSTEM: PLANITOP HPC TIXO

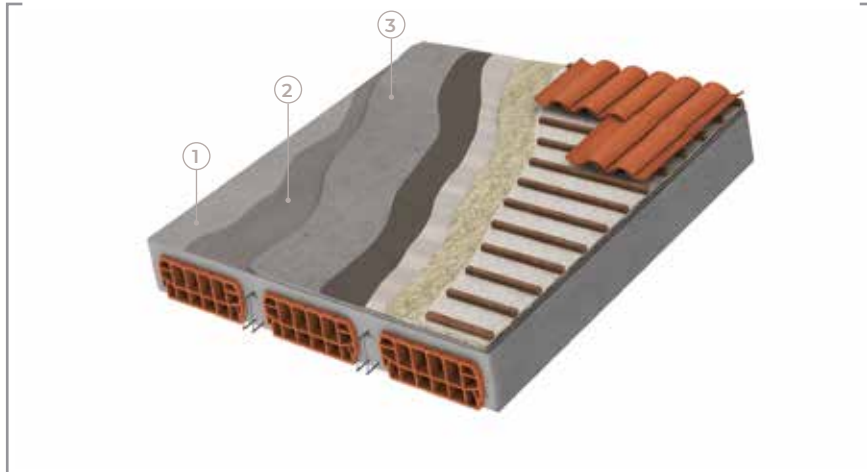

- 1 | EXISTING SLOPING BRICK-CONCRETE FLOOR SLAB
- 2 | PRIMER 3296
- 3 | PLANITOP HPC TIXO

APPLICATION PROCEDURE



Strengthening the extrados of a sloping floor slab may be carried out by integrating it with a structural screed made from **PLANITOP HPC TIXO** microconcrete. Prepare the substrate by stripping the existing flooring material down to the level of the existing screed and roughen the screed with power tools. The surface roughness must be at least 5 mm to ensure a good bond between the existing screed and **PLANITOP HPC TIXO**.

- Insert a series of dolly bars made from B450C rebar into holes drilled into the kerb around the floor slab parallel to the floor joists and anchor the dolly bars in place with **MAPEFIX EP 385** epoxy chemical anchor or **MAPEFIX VE SF** vinyl ester chemical anchor. Go over the surface with a vacuum cleaner to remove all traces of loose material.
- Consolidate the extrados of the existing screed with **PRIMER 3296** diluted 1:1 with water.
- At least 4 hours after applying the primer prepare **PLANITOP HPC TIXO** in a cement mixer.
- Pour **PLANITOP HPC TIXO** onto the floor slab to form a layer around 2 cm thick (l) (photos A, B and C).

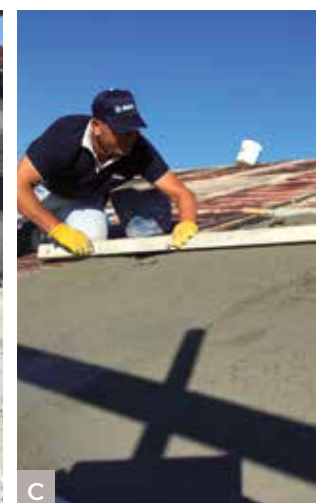

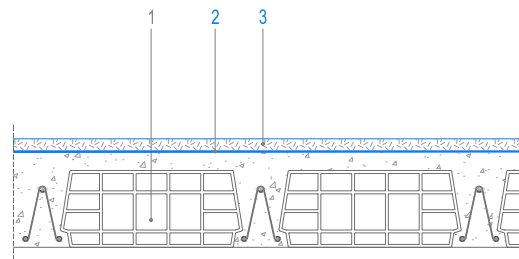
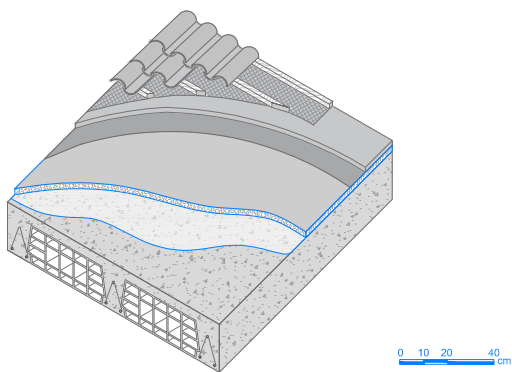
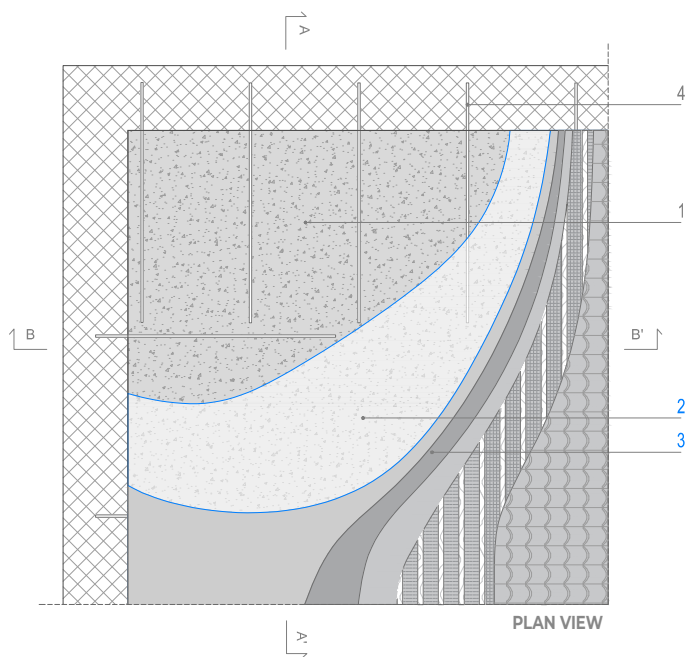

SECTION AA'

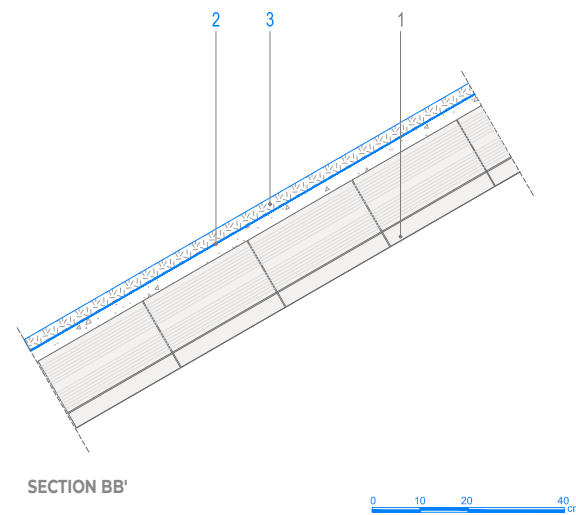

SECTION BB'

↓ NOTES

1. Use the **MAPEI STRUCTURAL DESIGN** calculation tool, which is compliant with CNR DT 204 guidelines, to define the thickness required for the layer of **PLANITOP HPC TIXO**.
2. If a second pour of **PLANITOP HPC TIXO** needs to be carried out, it is good practice to apply **EPORIP** or insert pieces of rebar.
3. Strengthening work using **PLANITOP HPC TIXO** does not require the use of connectors or electro-welded mesh.
4. **PLANITOP HPC TIXO** complies with the requirements of EN 1504-3 as R4 class structural mortar.

SCAN THE QR CODE

To download strengthening Data sheets, Technical data sheets, DWG, structural calculation software and other useful tips

or **DOWNLOAD FROM OUR WEBSITE**
www.rinforzo-strutturale.it



2.2

STRENGTHENING SYSTEMS

FOR MASONRY AND WOODEN BUILDINGS



Over the years, structures made from load-bearing masonry and wooden elements, typical of Italian building stock, have shown to be particularly vulnerable to earthquakes due to a number of factors.

Traditional strengthening techniques have not always been able to meet specified structural requirements or been suitable for architectural conservation work, which is why, in the recent past, other techniques have been developed that comply with the principles of compatibility with existing structures, such as reversibility of the intervention,

durability and the level of impact the intervention has on a structure's existing geometric configuration. Composite materials (**FRP** and **FRCM systems** in particular) have demonstrated their true worth (and economic sustainability) in carrying out their function of mitigating seismic risk according to these guiding principles.

TYPICAL COLLAPSE MECHANISMS IN MASONRY STRUCTURES



Collapse of masonry vaults



Shear cracks in load-bearing walls



Damage to skylights



Shear cracks



Façade overturning mechanisms



Damage to bell towers



Masonry with poor mechanical properties

STRENGTHENING SYSTEMS

FOR MASONRY AND WOODEN BUILDINGS

1. REPOINTING JOINTS IN “NATURAL-FINISH” MASONRY

- 1.a  Reinforced pointing with building mortar and **MAPEI STEEL BAR** helical stainless steel bars
-



2. REPAIRING CRACKS IN “NATURAL FINISH” MASONRY

- 2.a  Dry stitching with **MAPEI STEEL DRY** helical stainless steel bars
-

3. REPAIRING CRACKS IN LOAD-BEARING MASONRY

- 3.a  Localised crack repairs with the **FRCM SYSTEM**
-







4. REINFORCED STITCHING OF MASONRY

- 4.a  Reinforced stitching by injecting fluid slurry into carbon fibre tubes: **CARBOTUBE**
- 4.b  Dry stitching with helical stainless steel bars: **MAPEI STEEL DRY**
-





5. BINDING INTER-STOREY FLOORS WITH FRP

- 5.a  Binding inter-storey floors with FRP: **MAPEWRAP SYSTEM** fabrics
-

6. STRENGTHENING LOAD-BEARING MASONRY

- 6.a  Rehabilitating masonry by pointing constructing joints
- 6.b  Consolidation and strengthening by “stitching” or “filling”
- 6.c  Consolidation and strengthening by injecting hyper-fluid slurry
- 6.d  Strengthening to counteract out-of-plane and in-plane loads with FRP: **MAPEWRAP SYSTEM** fabrics
- 6.e  Strengthening to counteract out-of-plane and in-plane loads with low thickness render: **FRCM SYSTEM**
- 6.f  Strengthening with reinforced render: **MAPENET EM** system





7. STRENGTHENING OF MASONRY ARCHES AND VAULTS

- 7.a  Substrate preparation by pointing construction joints
 - 7.b  Consolidation and strengthening by injecting hyper-fluid slurry
 - 7.c  Cladding with FRP: **MAPEWRAP SYSTEM** fabrics
 - 7.d  Strengthening with low thickness reinforced render: **FRCM SYSTEM**
-



8. COMPLEMENTARY SYSTEMS

- 8.a  Transversal connectors made from **MAPEWRAP FIOCCO**
-

9. FLEXURAL STRENGTHENING OF WOODEN FLOOR BEAMS AND JOISTS

- 9.a  Substrate preparation and consolidation of wooden elements
 - 9.b  Flexural strengthening by cladding with **CARBOPLATE SYSTEM** carbon fibre plates
 - 9.c  Combined compressive and bending strengthening by inserting **MAPEROD** rods
 - 9.d  Reconstructing damaged ends and structural elements in wood
-

10. STRENGTHENING OF THE EXTRADOS OF FLOOR SLABS WITH A LOW THICKNESS STRUCTURAL SCREED

- 10.a  Strengthening wooden floor slabs with HPC SYSTEM structural screed: **PLANITOP HPC FLOOR**
- 10.b  Strengthening mixed-type floor slabs with HPC SYSTEM structural screed: **PLANITOP HPC FLOOR**

REPOINTING JOINTS IN “NATURAL-FINISH” MASONRY

REINFORCED POINTING WITH BUILDING MORTAR AND MAPEI STEEL BAR HELICAL STAINLESS STEEL BARS

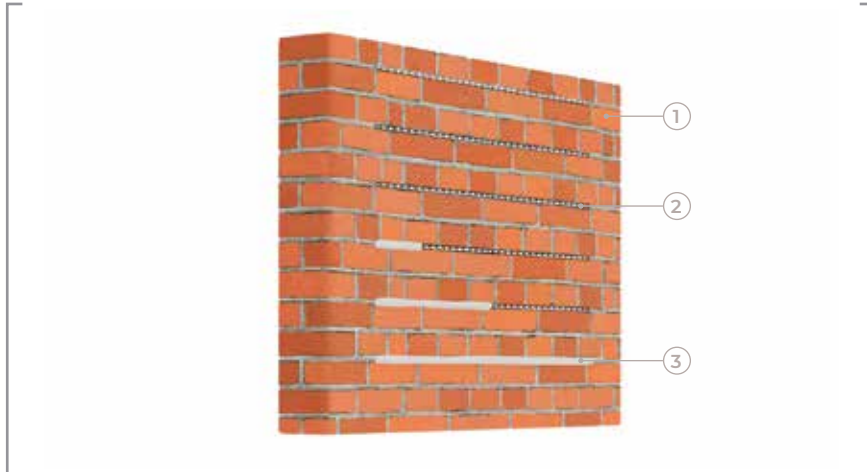

APPLICATION PROCEDURE



Reinforced pointing of joints between building blocks on “natural-finish” masonry may be carried out by embedding helical stainless steel bars in **PLANITOP HDM RESTAURO** or **MAPE-ANTIQUÉ ALLETTAMENTO** or, as an alternative, **MAPEWALL MURATURA FINE** mortar.

Proceed as follows:

- Remove the building mortar from the joints with power tools (photo A).
- Remove all dust with compressed air (photo B).
- Wash the surface of the area to be pointed with water at low-pressure (photo C).
- Cut the **MAPEI STEEL BAR** helical bars to the length required for the intervention with a hand grinder (photo D).
- Apply **PLANITOP HDM RESTAURO** or **MAPE-ANTIQUÉ ALLETTAMENTO** mortar in the joint or, as an alternative, **MAPEWALL MURATURA FINE** (photo E).
- Insert the **MAPEI STEEL BAR** along the line of the joint (photo F).
- After inserting the **MAPEI STEEL BAR**, fill the joint with the same mortar (**PLANITOP HDM RESTAURO**, **MAPE-ANTIQUÉ ALLETTAMENTO** or **MAPEWALL MURATURA FINE**) (photos G and H).



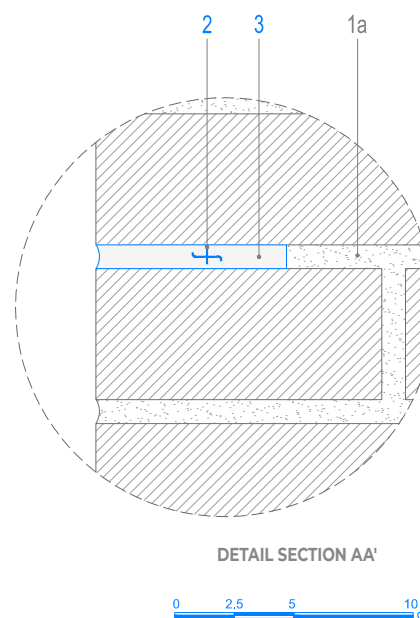
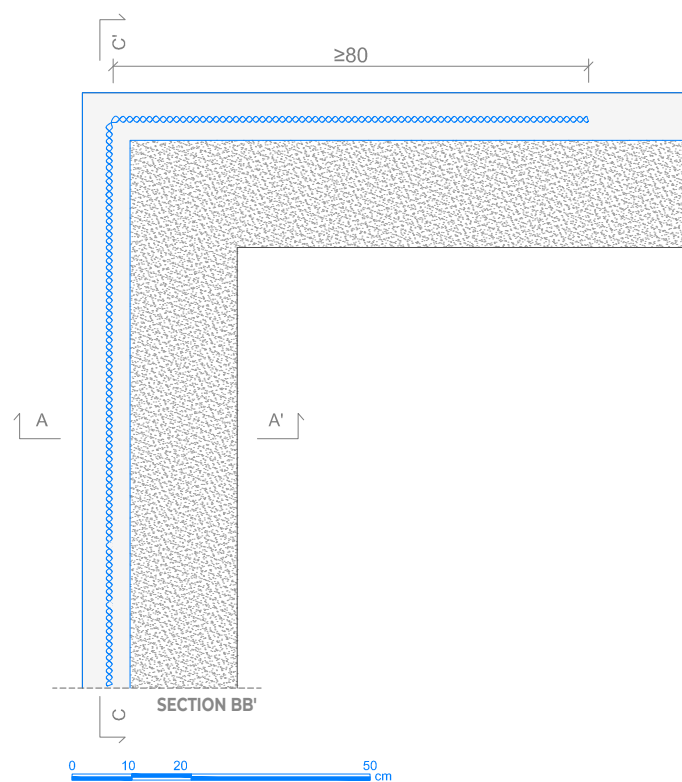
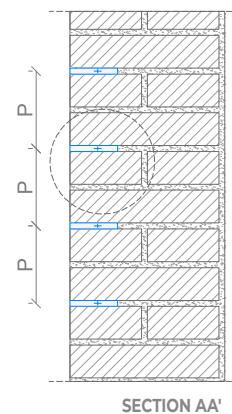
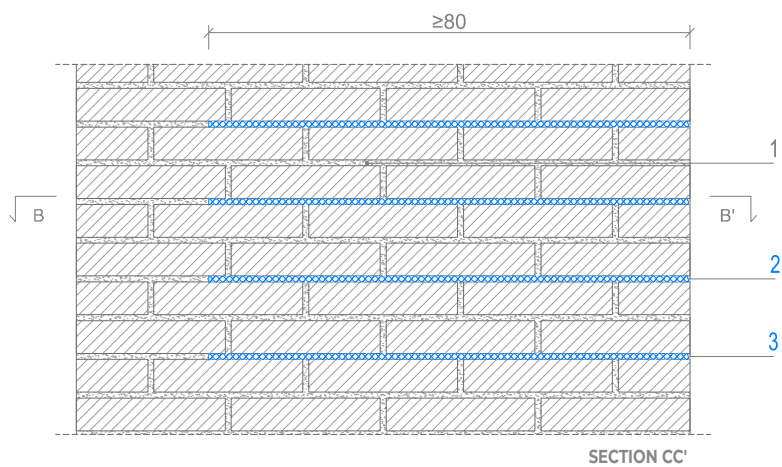

↓ NOTES

1. MAPE-ANTIQUE ALLETTAMENTO is available in 7 colours.
2. As an alternative to MAPEWALL MURATURA FINE it is also possible to use MAPEWALL MURATURA GROSSO and MAPEWALL RENDER & STRENGTHEN.

SCAN THE QR CODE
 To download strengthening Data sheets,
 Technical data sheets, DWG, structural
 calculation software and other useful tips
 or **DOWNLOAD FROM OUR WEBSITE**
www.rinforzo-strutturale.it



REPAIRING CRACKS IN “NATURAL FINISH” MASONRY

DRY STITCHING WITH MAPEI STEEL DRY HELICAL STAINLESS STEEL BARS

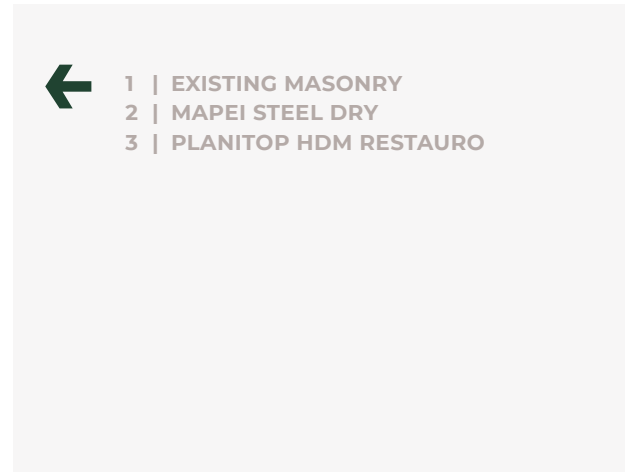
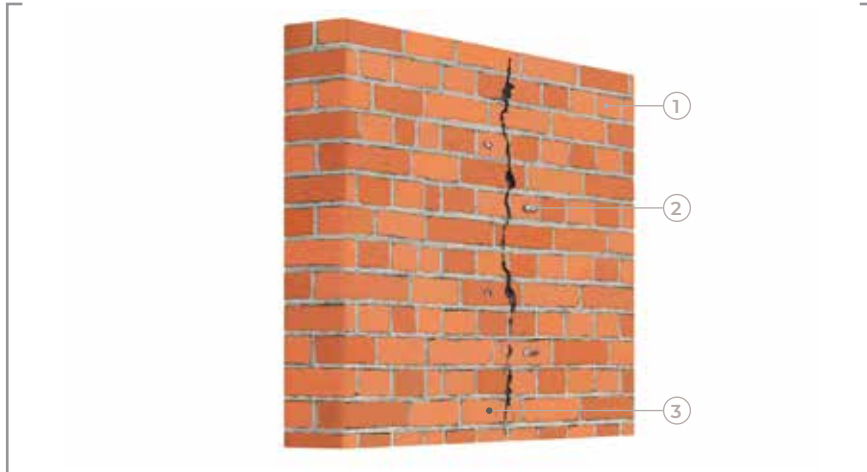

APPLICATION PROCEDURE



Stitching cracks in natural finish masonry may be carried out by dry-inserting **MAPEI STEEL DRY 316** helical AISI 316 stainless steel bars in a staggered criss-cross pattern along the crack. Before stitching the crack, and depending on the size of the crack, it may also be filled by injection (SHEET 4.A).

After completing this operation, proceed as follows:

- Starting from one side of the cracked masonry, drill a series of pilot-holes slightly smaller than the helical bars to be inserted until they reach the other side. (photo A).
- Remove any loose material from inside the holes with compressed air (photo B).
- Insert a piece of **MAPEI STEEL DRY 316** bar in each of the holes using a **Mapei Steel Mandril** attached to a drill with an **SDS** adapter. Drill the bar into the pilot hole using the hammer-drill option until it is completely inserted. Depending on the length of the piece of helical bar, a **Mapei Steel Extension** may be required (photo C).
- Make sure the bar is fully inserted in the hole (photo D).
- Once the bar has been inserted, grout the hole with **PLANITOP HDM RESTAURO** mortar (photo E).

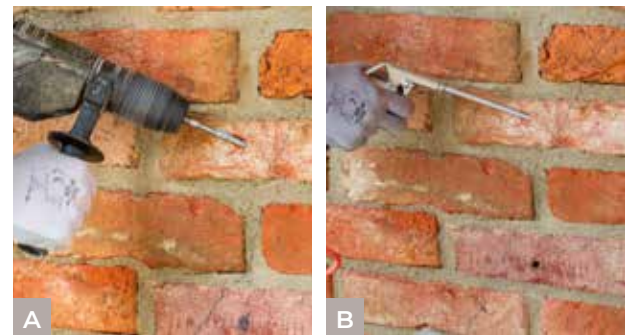

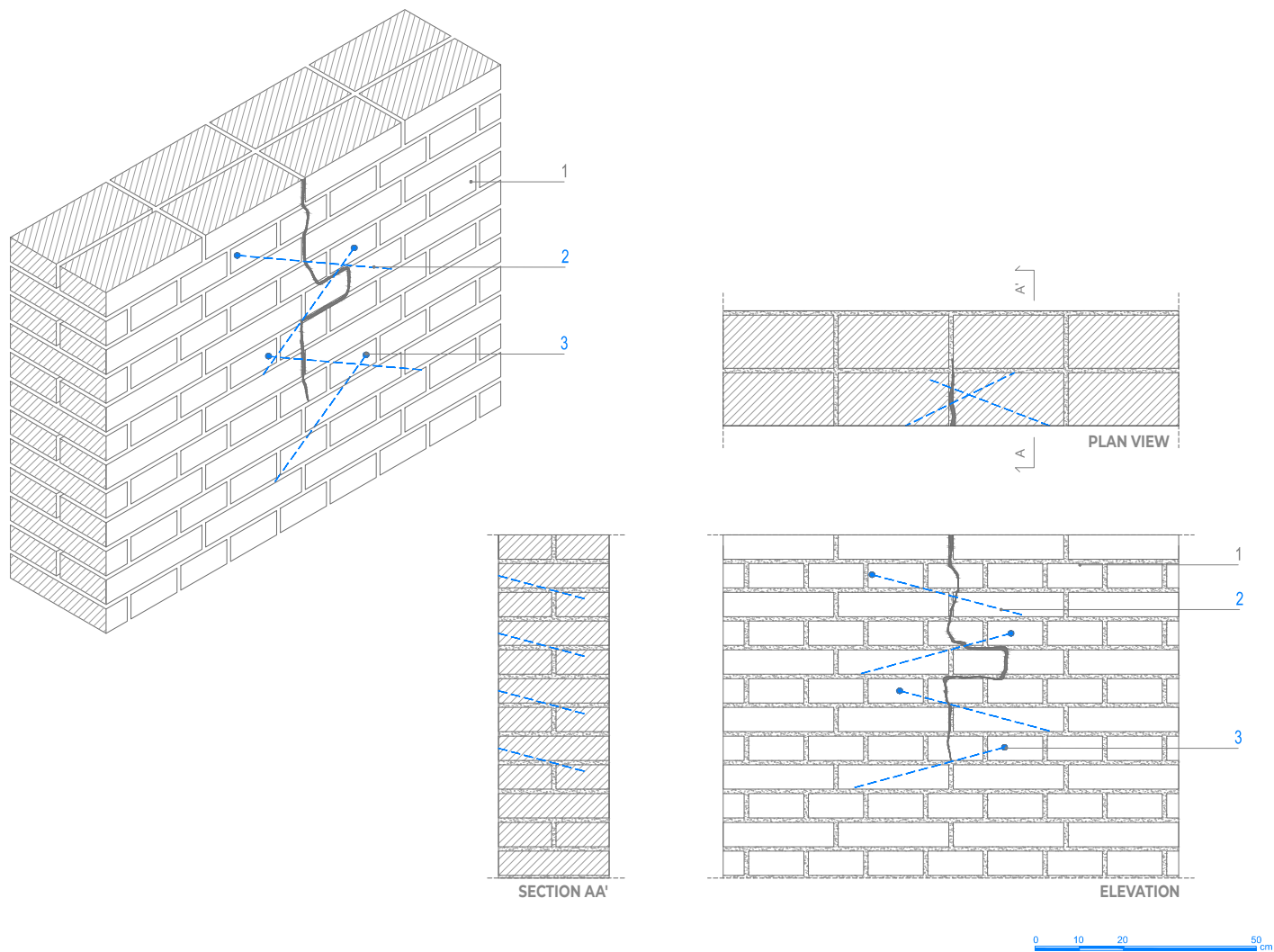

↓ NOTES

1. The diameter, layout, depth and pitch of the **MAPEI STEEL DRY** helical stainless steel bars must be calculated during the design stage.

SCAN THE QR CODE

To download strengthening Data sheets, Technical data sheets, DWG, structural calculation software and other useful tips

or **DOWNLOAD FROM OUR WEBSITE**
www.rinforzo-strutturale.it



REPAIRING CRACKS IN LOAD-BEARING MASONRY

LOCALISED CRACK REPAIRS WITH THE FRCM SYSTEM

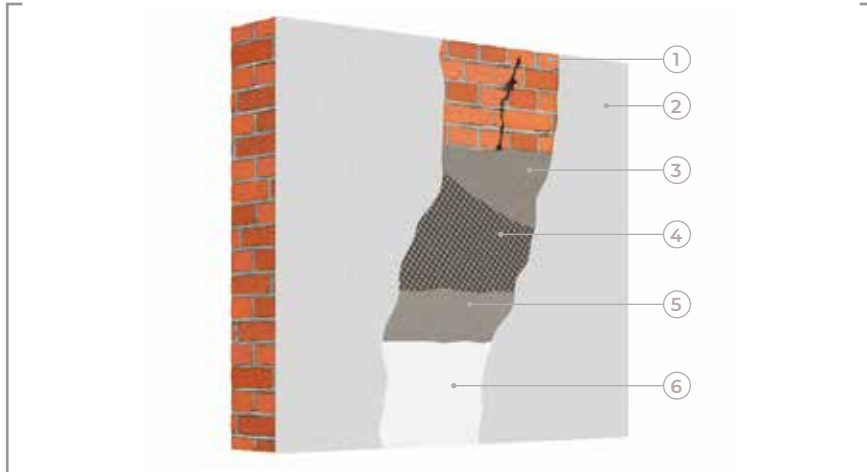

- 1 | EXISTING MASONRY
- 2 | EXISTING RENDER
- 3 | PLANITOP HDM MAXI or
PLANITOP HDM RESTAURO
- 4 | MAPEGRID G 220 or
MAPEGRID B 250
- 5 | PLANITOP HDM MAXI or
PLANITOP HDM RESTAURO
- 6 | SKIM-COAT

APPLICATION PROCEDURE



Localised crack repairs on load-bearing masonry (stone, brick, or tuff) may be carried out by applying a localised, compact, reinforced skim-coat comprising mesh from the **FRCM SYSTEM** line (**MAPEGRID B 250** or **MAPEGRID G 220**) combined with two-component, high-ductility, fibre-reinforced mortar (**PLANITOP HDM MAXI** or **PLANITOP HDM RESTAURO**).

Proceed as follows:

- Remove all the existing render around the area of the crack (from both the vertical masonry and the intrados of the vault) to form an area around 60-90 cm wide where the mortar can be applied. If necessary, consolidate the substrate by injection (SHEET 4.A) (photo A).
- Wash the surface of the area to be repaired with water at low-pressure (photo B).
- Apply a layer around 5-6 mm thick of **PLANITOP HDM MAXI** or **PLANITOP HDM RESTAURO** two-component, high-ductility, fibre-reinforced mortar.
- Lay **MAPEGRID G 220** A.R. alkali-resistant structural glass fibre mesh or **MAPEGRID B 250** basalt fibre mesh on the mortar while it is still fresh so that it straddles the crack; make sure the pieces of mesh overlap by around 15 cm (photo D).
- Apply a second layer around 5-6 mm thick of **PLANITOP HDM MAXI** or **PLANITOP HDM RESTAURO** while the first layer is still fresh (photo E).
- Wait until the mortar is fully cured and then skim the surface with a smoothing and levelling compound from the **PLANITOP** range or the **MAPE-ANTIQUÉ** range (photo F).

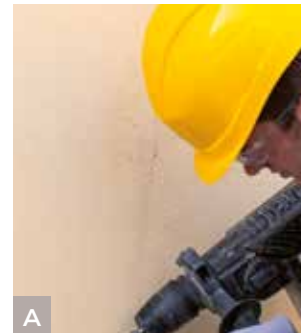

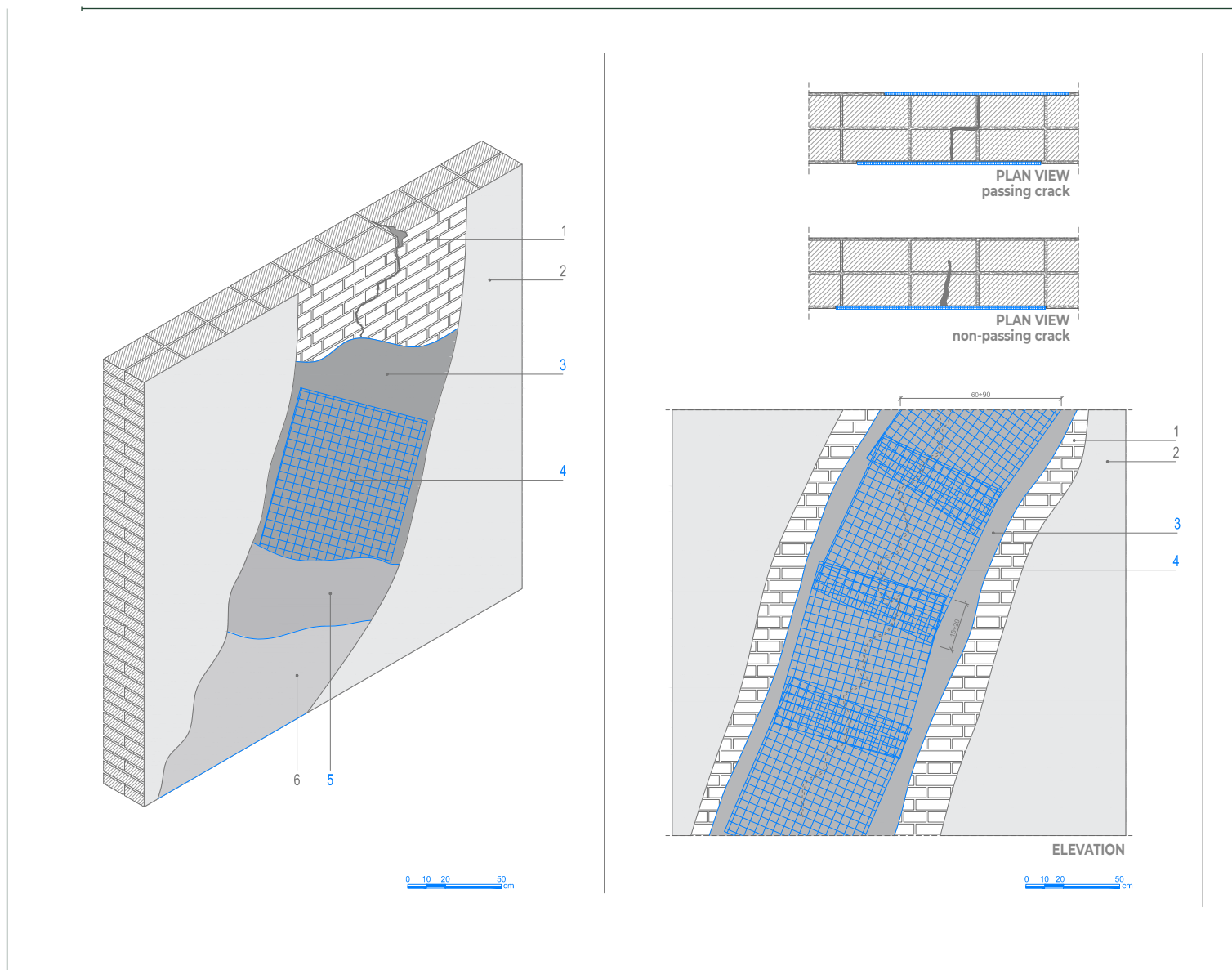

↓ NOTES

1. Depending on specific design conditions, A.R. alkali-resistant, glass fibre **MAPEGRID G 220** or basalt fibre **MAPEGRID B 250** mesh may be used.
2. **PLANITOP HDM RESTAURO** is a two-component, ready-mixed, high-ductility, natural hydraulic lime (NHL) and Eco-Pozzolan-based mortar specifically recommended for old masonry structures (listed buildings) to guarantee mechanical, physical and chemical compatibility with the materials used for the original masonry.
4. **PLANITOP HDM RESTAURO** complies with the requirements of EN 998-1 and EN 998-2 for M15 masonry mortar.
5. **PLANITOP HDM MAXI** is a two-component, high-ductility, fibre-reinforced cementitious mortar made from Pozzolan-reaction binder.
6. **PLANITOP HDM MAXI** complies with the requirements of EN 998-1 as GP type CS IV class render, of EN 998-2 for M25 masonry mortar and the requirements of EN 1504-3 for R2 class non-structural mortar.

SCAN THE QR CODE

To download strengthening Data sheets, Technical data sheets, DWG, structural calculation software and other useful tips

or **DOWNLOAD FROM OUR WEBSITE**
www.rinforzo-strutturale.it



REINFORCED STITCHING OF MASONRY

REINFORCED STITCHING BY INJECTING FLUID SLURRY INTO CARBOTUBE

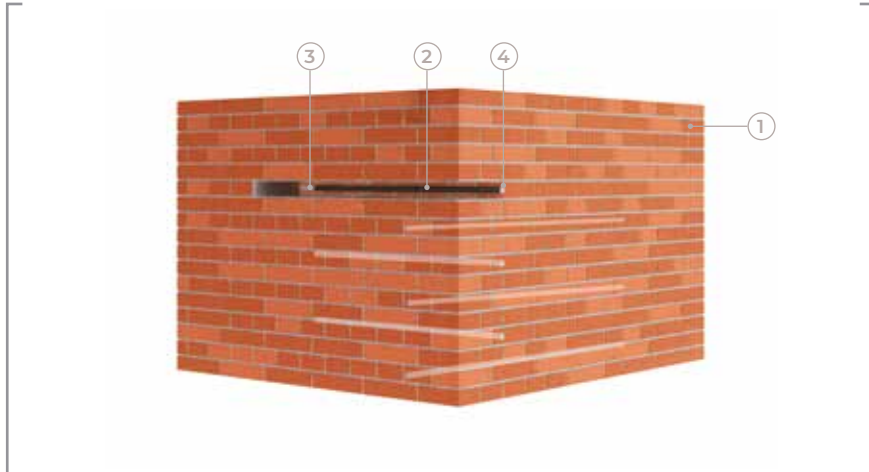

- 1 | EXISTING MASONRY
- 2 | CARBOTUBE
- 3 | MAPE-ANTIQUÉ I-15 or MAPEWALL INJECT & CONSOLIDATE
- 4 | MAPE-ANTIQUÉ ALLETTAMENTO or MAPEWALL MURATURA FINE

APPLICATION PROCEDURE



To ensure a masonry building has box-action type behaviour, it is possible to couple corner walls or T intersections together, or improve the way they are coupled together, to prevent them collapsing due to out-of-plane mechanisms by employing reinforced stitching with **CARBOTUBE**.

Proceed as follows:

- Drill a series of holes according to the layout calculated during the design phase so they intercept the facing wall to be connected (photo A). Drill $\varnothing 24$ mm holes (to insert the reinforcement and injected material) perpendicular or at a slight angle to the wall (an angle of around 5° is recommended so that the injected slurry can flow freely).
- Remove all loose material from inside the holes with compressed air (photo B).
- Grout the joints in the wall with mortar with similar physical and mechanical characteristics as the old mortar (**MAPE-ANTIQUÉ ALLETTAMENTO** or **MAPEWALL MURATURA FINE**) (photo C).
- Wash the surface of the area to be repaired with water at low-pressure (photo D).
- Remove the protective peel-ply film from **CARBOTUBE** (photo E).
- Fasten a $\varnothing 23$ mm INJECTOR with a non-return valve to the end of each piece of **CARBOTUBE** (photo F).
- Insert the **CARBOTUBE** into the holes (photo G).
- Fasten the $\varnothing 23$ mm INJECTOR in such a way that its special shape allows air to be released during the injection phase (photo H).
- Prepare the slurry by mixing **MAPE-ANTIQUÉ I-15** binder or **MAPEWALL INJECT & CONSOLIDATE** so that it may be injected (photo I).
- Remove the $\varnothing 23$ mm INJECTORS and grout the holes with **MAPE-ANTIQUÉ ALLETTAMENTO** or **MAPEWALL MURATURA FINE** (photo J).



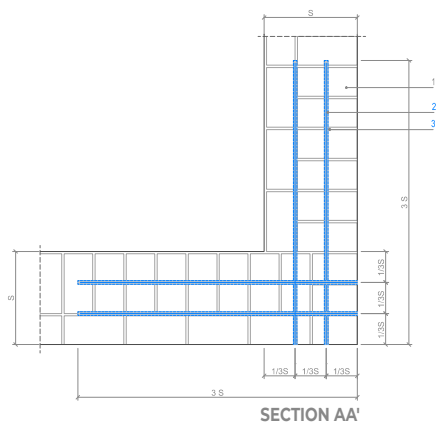

SECTION AA'

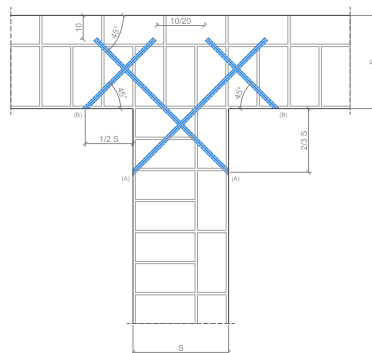
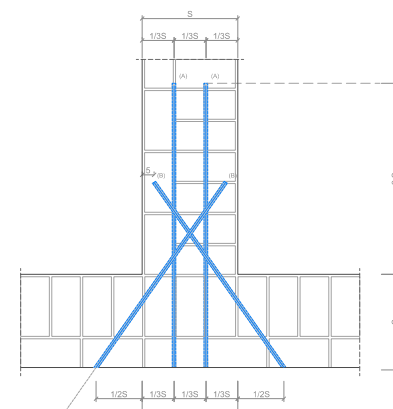
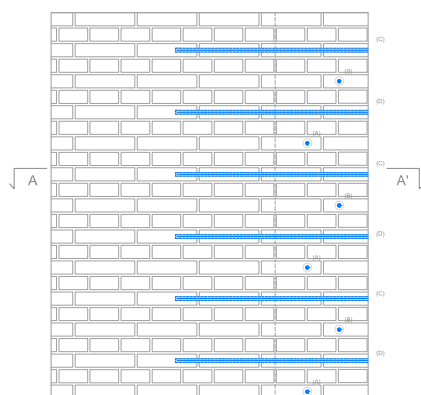
SECTION BB'
(internal stitching)SECTION CC'
(external stitching)

ELEVATION A

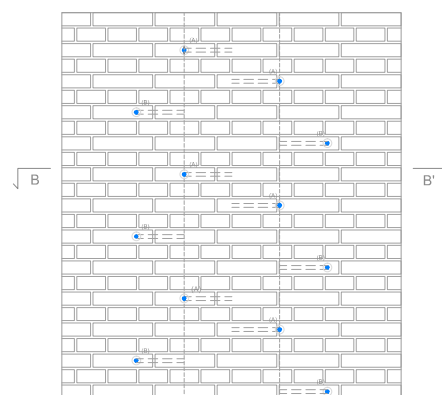

ELEVATION B

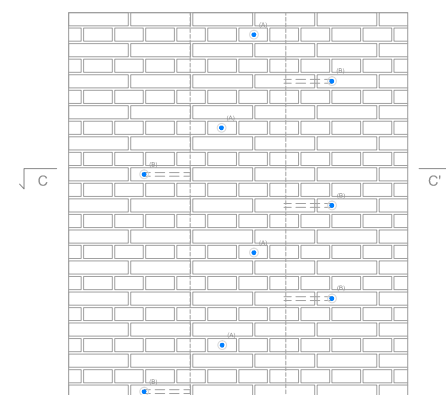

ELEVATION C

0 10 20 50
cm

NOTES

1. The layout, depth and pitch of the **CARBOTUBE** must be calculated during the design stage.
2. **MAPE-ANTIQUÉ I-15** is a cement-free, salt-resistant, fillerized, lime and Eco-Pozzolan-based hydraulic binder for making super-fluid injectable slurry for consolidating masonry and is specifically recommended for old masonry structures (listed buildings) to guarantee mechanical, physical and chemical compatibility with the materials used for the original masonry.
3. As an alternative to **MAPE-ANTIQUÉ I-15** it is possible to use **MAPE-ANTIQUÉ I** or **MAPE-ANTIQUÉ F21**.
4. **MAPEWALL INJECT & CONSOLIDATE** is a natural hydraulic lime-based, reactive inorganic binder with very low emission of VOC for making super-fluid injectable slurry for consolidating masonry.

SCAN THE QR CODE

To download strengthening Data sheets, Technical data sheets, DWG, structural calculation software and other useful tips

or **DOWNLOAD FROM OUR WEBSITE**
www.rinforzo-strutturale.it



REINFORCED STITCHING OF MASONRY

DRY STITCHING WITH HELICAL STAINLESS STEEL BARS:

MAPEI STEEL DRY

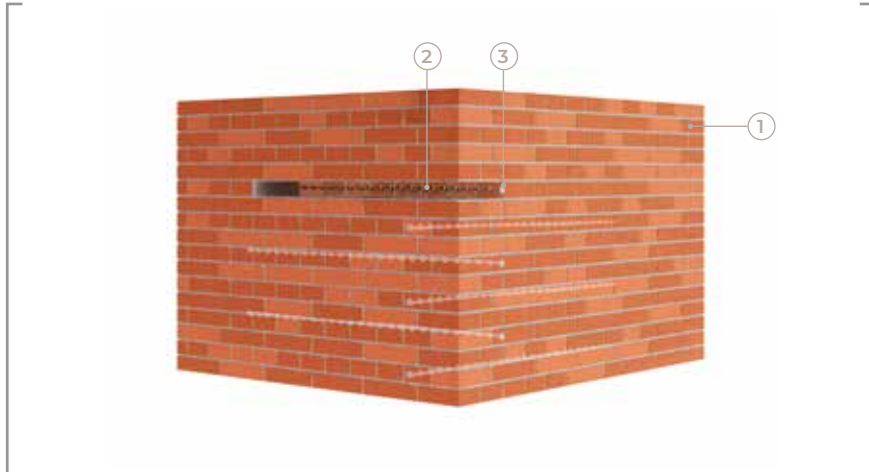

- 1 | EXISTING MASONRY
- 3 | MAPEI STEEL DRY
- 2 | MAPE-ANTIQUE ALLETTAMENTO or MAPEWALL MURATURA FINE

APPLICATION PROCEDURE



To ensure a masonry building has box-action type behaviour, it is possible to couple corner walls or T intersections together, or improve the way they are coupled together, to prevent them collapsing due to out-of-plane mechanisms by employing reinforced stitching with **MAPEI STEEL DRY 316**.

Proceed as follows:

- Drill a series of pilot-holes according to the layout calculated during the design phase so they intercept the facing wall to be connected. The diameter of the holes must be slightly smaller than the helical bars to be inserted. The depth of the pilot hole must be the same or deeper than the length of the bar used to stitch the walls (photo A).
- Remove all loose material from inside the holes with compressed air (photo B).
- Attach a **Mapei Steel Mandril** to a drill using an SDS adapter (photo C).
- Insert the piece of **MAPEI STEEL DRY 316** bar inside the hole. Drill the helical bar completely into the pilot hole with the hammer-drill option. Depending on the length of the piece of helical bar, a **Mapei Steel Extension** may be required (photo D).
- After inserting the helical bar, grout the holes with **MAPE-ANTIQUE ALLETTAMENTO** or **MAPEWALL MURATURA FINE** (photo E).

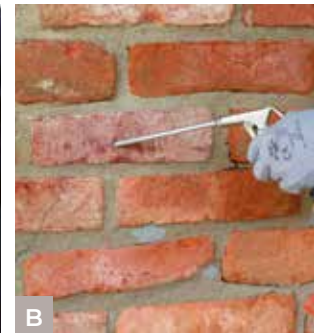

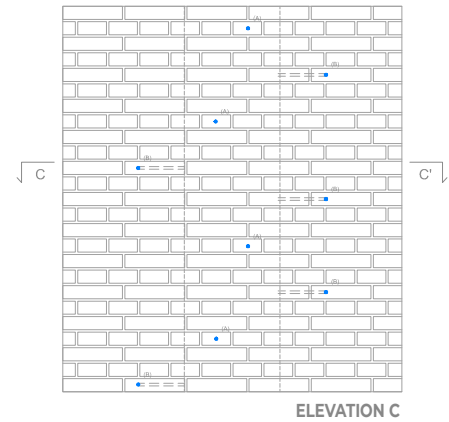
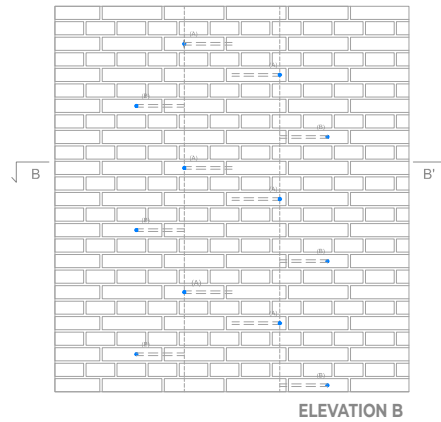
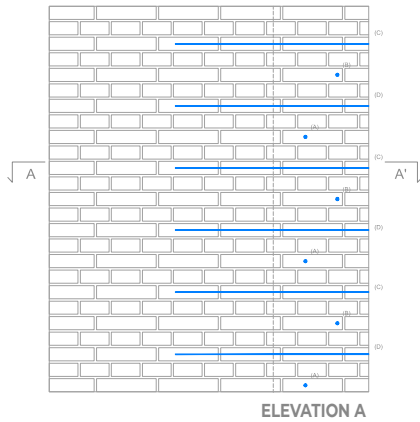
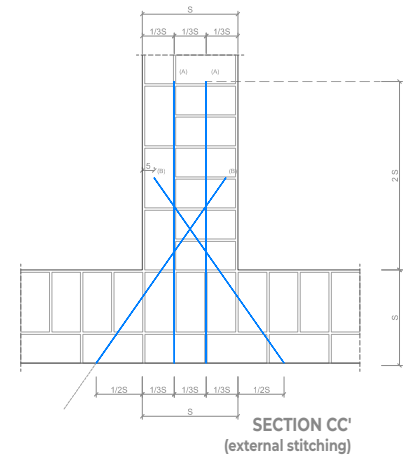
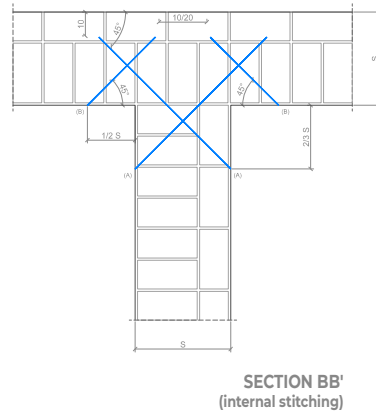
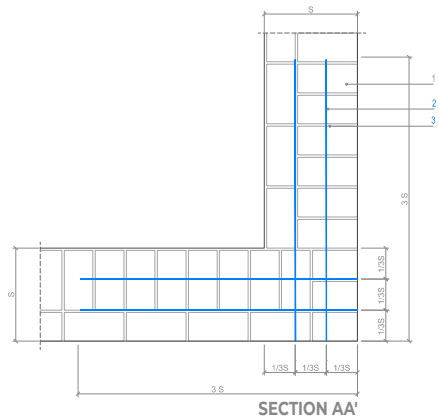

0 10 20 50 cm

NOTES

1. The diameter, layout, depth and pitch of the MAPEI STEEL DRY helical stainless steel bars must be calculated during the design stage.

SCAN THE QR CODE
To download strengthening Data sheets,
Technical data sheets, DWG, structural
calculation software and other useful tips
or **DOWNLOAD FROM OUR WEBSITE**
www.rinforzo-strutturale.it



BINDING INTER-STOREY FLOORS WITH FRP

BINDING INTER-STOREY FLOORS WITH FRP: MAPEWRAP SYSTEM FABRICS

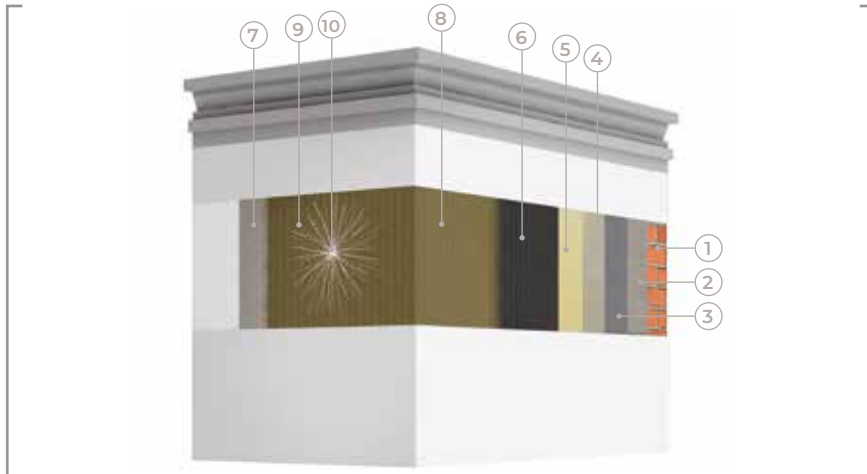

- 1 | EXISTING MASONRY
- 2 | PLANITOP HDM MAXI or
PLANITOP HDM RESTAURO
- 3 | MAPEWRAP PRIMER 1
- 4 | MAPEWRAP 11/12
- 5 | MAPEWRAP 31
- 6 | MAPEWRAP UNI-AX
- 7 | QUARTZ 1.2
- 8 | MAPEWRAP 31
- 9 | MAPEWRAP FIOCCO
- 10 | MAPEFIX VE SF

APPLICATION PROCEDURE



To ensure a masonry building has box-action type behaviour, it is possible to create an external band (or a partial band) made from fabrics from the **FRP SYSTEM** line at the level of each inter-storey floor and under the roof of the building. In the area where the work is to be carried out, remove the render, round-off any sharp edges in the masonry to a radius of at least 20 mm and then clean the surface. If the surface is uneven, level it off with a layer around 5-6 mm thick of two-component, high-ductility, fibre-reinforced mortar (**PLANITOP HDM MAXI** or **PLANITOP HDM RESTAURO**). Once the mortar has cured, apply a complete or partial band of fabric as follows:

- Apply a coat of **MAPEWRAP PRIMER 1** two-component primer over the levelling layer (photo A).
- While the primer is still fresh, apply an even layer 1.0-1.5 mm thick of **MAPEWRAP 11** or **MAPEWRAP 12** epoxy putty (*) (photo B).
- While the epoxy grout is still fresh, apply a layer of **MAPEWRAP 31** fluid epoxy resin to impregnate the fabric (photo C).
- Cut the **MAPEWRAP C UNI-AX** fabric to the length required with scissors.
- Lay the **MAPEWRAP C UNI-AX** on the resin and go over it with a **MAPEWRAP ROLLER** to eliminate any air bubbles; make sure the pieces of fabric overlap by at least 20 cm (photo D).
- Apply a second layer of **MAPEWRAP 31** (photo E).
- Broadcast the resin while still fresh with dry **QUARTZ 1.2** sand.

Where the **MAPEWRAP C UNI-AX** fabric changes direction and around the edges of the structure, it is recommended to add transversal connectors made from **MAPEWRAP FIOCCO** (SHEET 8.A). The connectors eliminate any "de-bonding" phenomenon and increase the static efficiency of the strengthening package applied.

(*) If a longer workability time is required use **MAPEWRAP 12**.

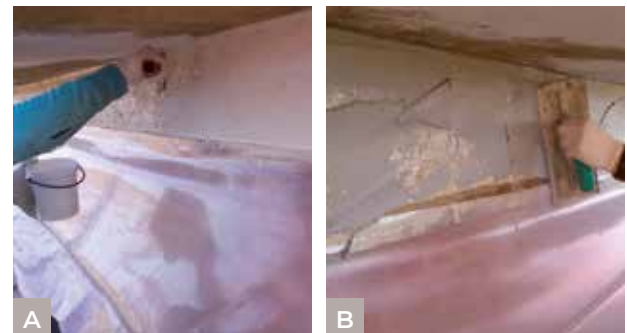

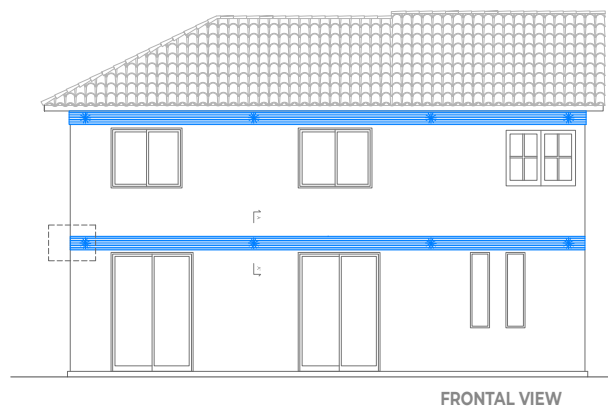

FRONTAL VIEW

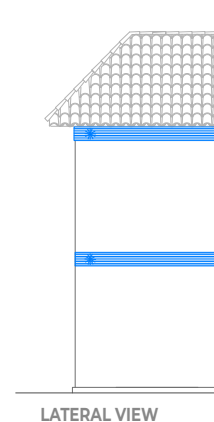

LATERAL VIEW

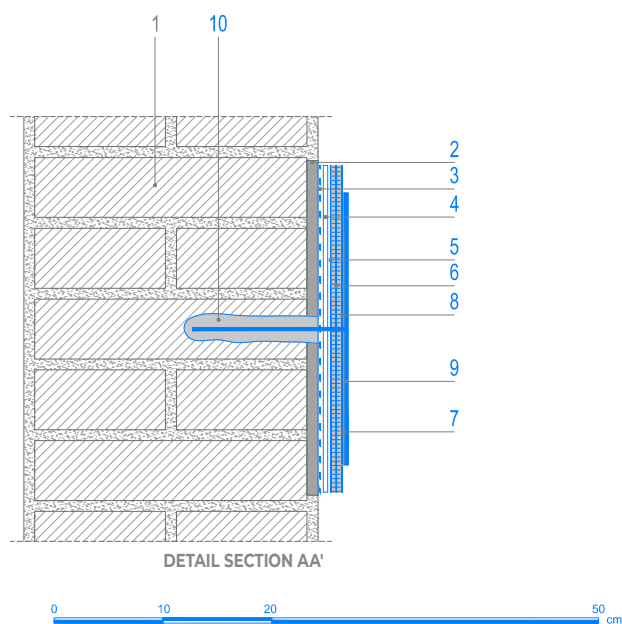

DETAIL SECTION AA'

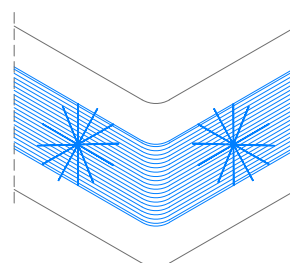
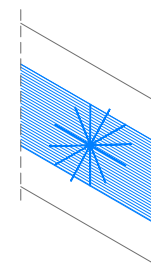
DETAIL AXONOMETRIC
PROJECTION-CORNERDETAIL AXONOMETRIC
PROJECTION-WALL

0 10 20 50 cm

↓ NOTES

1. Use the **MAPEI STRUCTURAL DESIGN** calculation tool, which is compliant with CNR DT 200 guidelines, to define the characteristics of the **MAPEWRAP UNI-AX** fabric (type of fibre, weight, modulus of elasticity, dimensions and number of layers).
2. The number, type, diameter and size of the **MAPEWRAP FIOCCO** transversal connectors must be defined during the design phase.

SCAN THE QR CODE

To download strengthening Data sheets, Technical data sheets, DWG, structural calculation software and other useful tips

or **DOWNLOAD FROM OUR WEBSITE**
www.rinforzo-strutturale.it



STRENGTHENING OF LOAD-BEARING MASONRY

REHABILITATING MASONRY BY POINTING CONSTRUCTING JOINTS

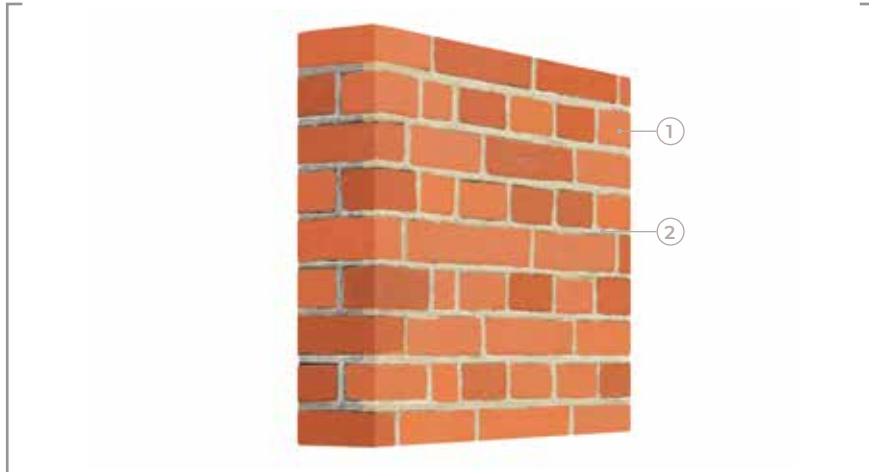

APPLICATION PROCEDURE

Proceed as follows to point load-bearing stone, brick and tuff masonry, including masonry of historical and artistic interest:

- Prepare the substrate by scraping out the joints between the blocks with hand tools or power tools, without affecting the integrity of the masonry, until the substrate is sound and compact and free of any loose materials, dust and mould.
- Clean the masonry by low-pressure hydro-cleaning to remove all traces of efflorescence and soluble salts from the surface.
- Saturate the substrate with water to prevent it drawing off water from the mortar and affecting its final performance characteristics. Eliminate any excess water with compressed air.
- Apply one or more layers of **MAPE-ANTIQUE ALLETTAMENTO** or **MAPEWALL MURATURA FINE**, depending on the depth and length of the courses to be filled, while pressing down slightly to ensure a good bond with the substrate (photos A and B). Remove any excess mortar immediately after application, including from the construction elements (photos C and D).

On “exposed-finish” masonry, go over the mortar joints between the construction elements with a damp sponge. If required, apply a transparent, breathable and water-repellent protective product.

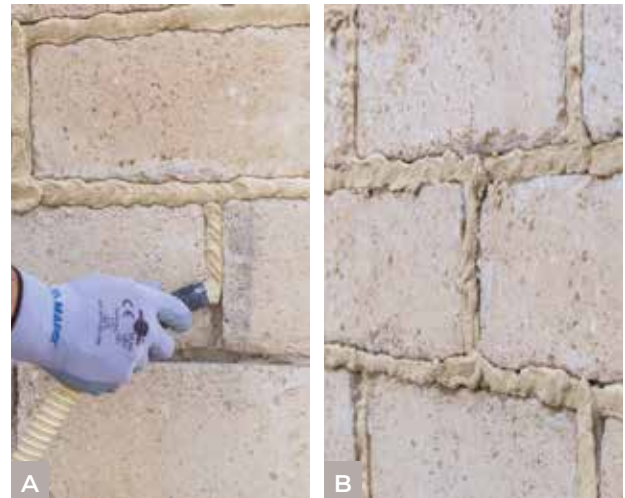

NOTES

1. **MAPE-ANTIQUE ALLETTAMENTO** is available in 7 colours.
2. As an alternative to **MAPEWALL MURATURA FINE** it is also possible to use **MAPEWALL MURATURA GROSSO** and **MAPEWALL RENDER & STRENGTHEN**.

STRENGTHENING OF LOAD-BEARING MASONRY CONSOLIDATION AND STRENGTHENING BY “STITCHING” OR “FILLING”

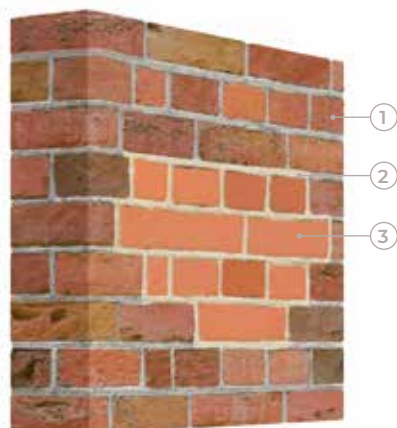

- 1 | EXISTING MASONRY
- 2 | MAPE-ANTIQUE ALLETTAMENTO
- 3 | NEW BRICKS/BLOCKS

APPLICATION PROCEDURE



Regenerating masonry elements using the “stitching” or “filling” techniques is required when a wall-face is badly deteriorated, if bricks or blocks are missing or if the wall is cracked, uneven and, in general, if there are problems in the way different areas of the masonry are connected.

Make the building safe by adopting temporary measures and then proceed as follows:

- Remove any particularly loose or damaged bricks or blocks.
- Remove any areas of the masonry where there are cracks or gaps, starting from the bottom working upwards, by removing deteriorated and/or cracked elements, any unsuitable installation mortar and any other elements or objects that could compromise restoration of the masonry (photo A). While carrying out this operation, put all the elements in good condition and which may be reused to restore and “patch up” the masonry together on one side. Also, while removing the deteriorated areas, leave rough edges to offer better grip between the areas of new masonry and existing masonry.
- Clean all support and jointing surfaces with a low-pressure hydro-cleaner, where possible, to help the mortar adhere to the substrate.
- “Patch” or “fill” the face of the wall by creating an “installation bed” of mortar with **MAPE-ANTIQUE ALLETTAMENTO** or **MAPEWALL MURATURA FINE** (photo B), and then lay the elements on the mortar (either the original ones previously removed or new ones with the same shape and size of the existing elements to prevent physical or chemical incompatibility). Press the elements down slightly so they form a better grip with the existing ones (photo C). Remove excess mortar with a trowel.



↓ NOTES

1. **MAPE-ANTIQUE ALLETTAMENTO** is available in 7 colours.
2. As an alternative to **MAPEWALL MURATURA FINE** it is also possible to use **MAPEWALL MURATURA GROSSO** and **MAPEWALL RENDER & STRENGTHEN**.

STRENGTHENING OF LOAD-BEARING MASONRY CONSOLIDATION AND STRENGTHENING BY INJECTING HYPER-FLUID SLURRY

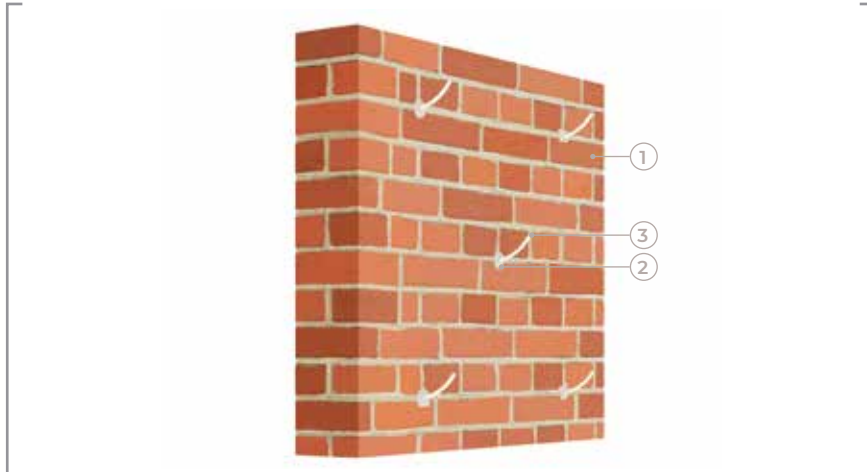

APPLICATION PROCEDURE



To consolidate structures made from core-filled masonry that has become unstable and/or loose with hyper-fluid, salt-resistant, volumetrically stable slurry, which is easy to inject with manual and electronic pumps or by gravity, proceed as follows:

- Prepare the substrate by grouting and “sealing” any cracks and gaps in the wall face where the slurry could seep out with **MAPE-ANTIQUE ALLETTAMENTO** or **MAPEWALL MURATURA FINE**.
- Drill a series of 20-40 mm diameter holes to a depth of 2/3 of the thickness of the wall, preferably at a square pitch of 50x50 cm. If the wall is thicker than 60 cm, it is good practice to drill the holes from both sides (photo A).
- Fasten tubes or injectors in the holes with **MAPE-ANTIQUE ALLETTAMENTO** or **MAPEWALL MURATURA FINE** so that the slurry made from **MAPE-ANTIQUE I-15** or **MAPEWALL INJECT & CONSOLIDATE** may be injected (photos B and C).
- The day before injecting the slurry, it is recommended to saturate the inside of the structure with water through the tubes or injectors previously fastened in place. Saturate the wall starting with the holes in the highest position. Make sure the structure has absorbed all the water before injecting the slurry, which must be carried out starting at the bottom of the wall working upwards (photo D).
- Remove the tubes or injectors and grout the holes with **MAPE-ANTIQUE ALLETTAMENTO** or **MAPEWALL MURATURA FINE** (photo E).



 **NOTES**

1. **MAPE-ANTIQUE I-15** is a cement-free, salt-resistant, fillerized, lime and Eco-Pozzolan-based hydraulic binder for making super-fluid injectable slurry for consolidating masonry and is specifically recommended for old masonry structures (listed buildings) to guarantee mechanical, physical and chemical compatibility with the materials used for the original masonry.
2. As an alternative to **MAPE-ANTIQUE I-15** it is possible to use **MAPE-ANTIQUE I** or **MAPE-ANTIQUE F21**.
3. **MAPEWALL INJECT & CONSOLIDATE** is a natural hydraulic lime-based, reactive inorganic binder with very low emission of VOC for making super-fluid injectable slurry to consolidate masonry.

STRENGTHENING OF LOAD-BEARING MASONRY

STRENGTHENING TO COUNTERACT OUT-OF-PLANE AND IN-PLANE LOADS WITH FRP: MAPEWRAP SYSTEM FABRICS

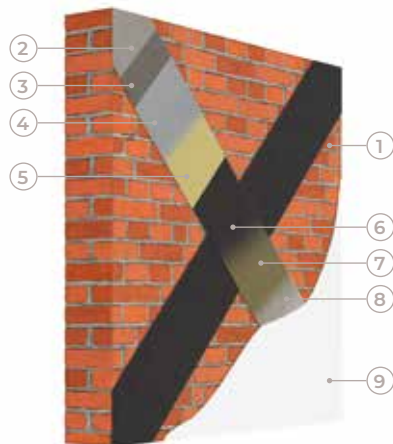

- ←
- 1 | EXISTING MASONRY
 - 2 | PLANITOP HDM MAXI
 - 3 | MAPEWRAP PRIMER 1
 - 4 | MAPEWRAP 11/12
 - 5 | MAPEWRAP 31
 - 6 | MAPEWRAP UNI-AX
 - 7 | MAPEWRAP 31
 - 8 | QUARTZ 1.2
 - 9 | FINISH

APPLICATION PROCEDURE

Shear/tensile and combined compressive/bending strengthening for load-bearing masonry (stone, brick and tuff) may be carried out by applying fabrics from the **FRP SYSTEM** line. After preparing the substrate, strengthen the masonry as follows:

If the surface to be strengthened is particularly uneven, it is recommended to apply a skim-coat along the main runs of the tensile loads with a fairly flat layer around 5-6 mm thick of **PLANITOP HDM MAXI** or **PLANITOP HDM RESTAURO** two-component, high-ductility, fibre-reinforced mortar. Once the mortar has cured, apply the **MAPEWRAP** fabric as follows:

- Apply **MAPEWRAP PRIMER 1** two-component epoxy primer on the surface to be strengthened (photo A).
 - While the primer is still fresh, apply an even layer 1.0-1.5 mm thick of **MAPEWRAP 11** or **MAPEWRAP 12** two-component epoxy putty with a trowel (*) (photo B).
 - While the epoxy putty is still fresh, apply a layer of **MAPEWRAP 31** fluid epoxy resin to impregnate the fabric (photo C).
 - Cut the **MAPEWRAP C UNI-AX** fabric to the length required with a pair of scissors (photo D).
 - While the **MAPEWRAP 31** resin is still fresh apply the **MAPEWRAP UNI-AX** fabric (photo E).
 - Go over the fabric with a **MAPEWRAP ROLLER** to eliminate any air bubbles (photo F).
 - Apply a second layer of **MAPEWRAP 31** (photo G).
 - Broadcast the resin while still fresh with dry **QUARTZ 1.2** sand (photo H).
- (*) If a longer workability time is required use **MAPEWRAP 12**.



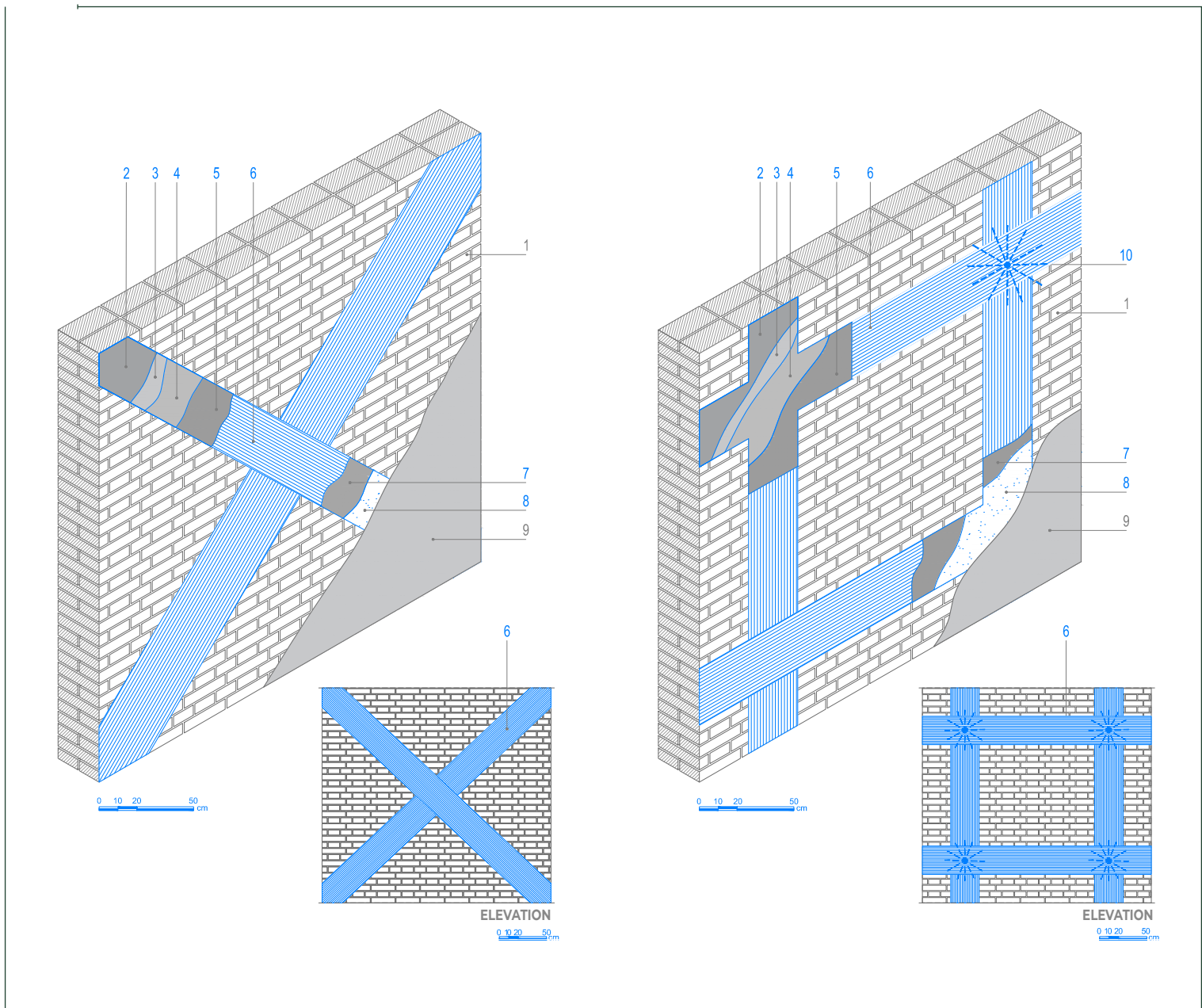

↓ NOTES

1. Depending on design requirements, it is possible to use **MAPEWRAP C UNI-AX** unidirectional carbon fibre fabric, **MAPEWRAP G UNI-AX** glass fibre fabric or **MAPEWRAP B UNI-AX** basalt fibre fabric, which are all available in various weights.

2. **PLANITOP HDM RESTAURO** is a two-component, ready-mixed, high-ductility, natural hydraulic lime (NHL) and Eco-Pozzolan-based mortar specifically recommended for old masonry structures (listed buildings) to guarantee mechanical, physical and chemical compatibility with the materials used for the original masonry.

3. **PLANITOP HDM MAXI** is a two-component, high-ductility, fibre-reinforced mortar containing Pozzolan-reaction binders.

SCAN THE QR CODE

To download strengthening Data sheets, Technical data sheets, DWG, structural calculation software and other useful tips

or **DOWNLOAD FROM OUR WEBSITE**
www.rinforzo-strutturale.it



STRENGTHENING OF LOAD-BEARING MASONRY

STRENGTHENING TO COUNTERACT OUT-OF-PLANE AND IN-PLANE LOADS WITH LOW THICKNESS RENDER: FRCM SYSTEM

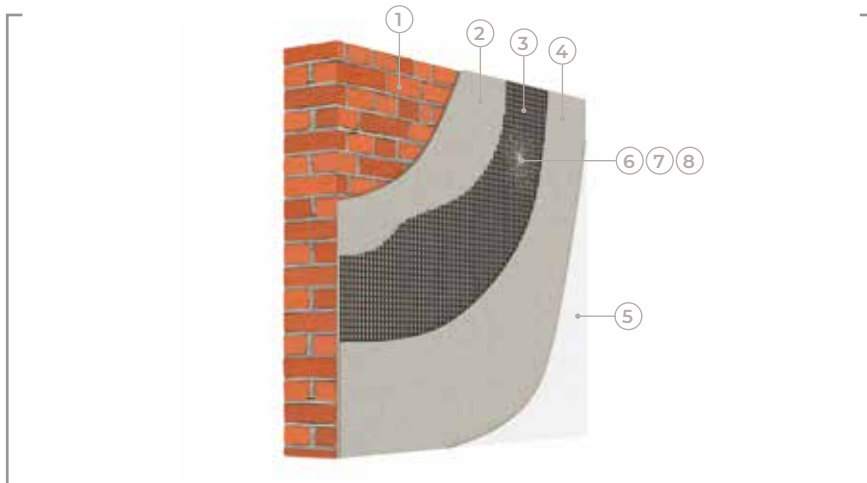

- 1 | EXISTING MASONRY
- 2 | PLANITOP HDM MAXI or PLANITOP HDM RESTAURO
- 3 | MAPEGRID G 220 or MAPEGRID B 250
- 4 | PLANITOP HDM MAXI or PLANITOP HDM RESTAURO
- 5 | FINISH
- 6 | MAPEWRAP C/G/B FIOCCO
- 7 | MAPEFIX VE SF
- 8 | MAPEWRAP 31

APPLICATION PROCEDURE



Shear/tensile strengthening for load-bearing masonry (stone, brick and tuff) may be carried out by applying “compact reinforced render” consisting of mesh from the **FRCM SYSTEM** line (**MAPEGRID B 250** or **MAPEGRID G 220**) in combination with two-component, high-ductility, fibre-reinforced mortar (**PLANITOP HDM MAXI** or **PLANITOP HDM RESTAURO**). After removing the render and preparing the substrate proceed as follows:

→ Level off the faces of the masonry with a 5-6 mm thick layer of **PLANITOP HDM MAXI** or **PLANITOP HDM RESTAURO** two-component, high-ductility, fibre-reinforced mortar (photo A).

→ Lay **MAPEGRID G 220** A.R. alkali-resistant structural glass fibre mesh or **MAPEGRID B 250** basalt fibre mesh on the mortar while it is still fresh; make sure the pieces of mesh overlap lengthways by around 10 cm (photo B).

→ Apply a second layer around 5-6 mm thick of **PLANITOP HDM MAXI** or **PLANITOP HDM RESTAURO** over the mesh while the first layer is still fresh (photo C).

Depending on the type of masonry to be strengthened, the design engineer may decide to apply the strengthening system on both faces, or on one face only using transversal connectors made from **MAPEWRAP FIOCCO** (SHEET 8.A). The connectors eliminate any “de-bonding” phenomenon and increase the static efficiency of the strengthening package applied.

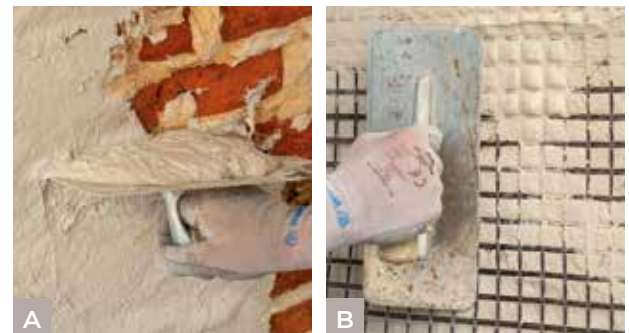

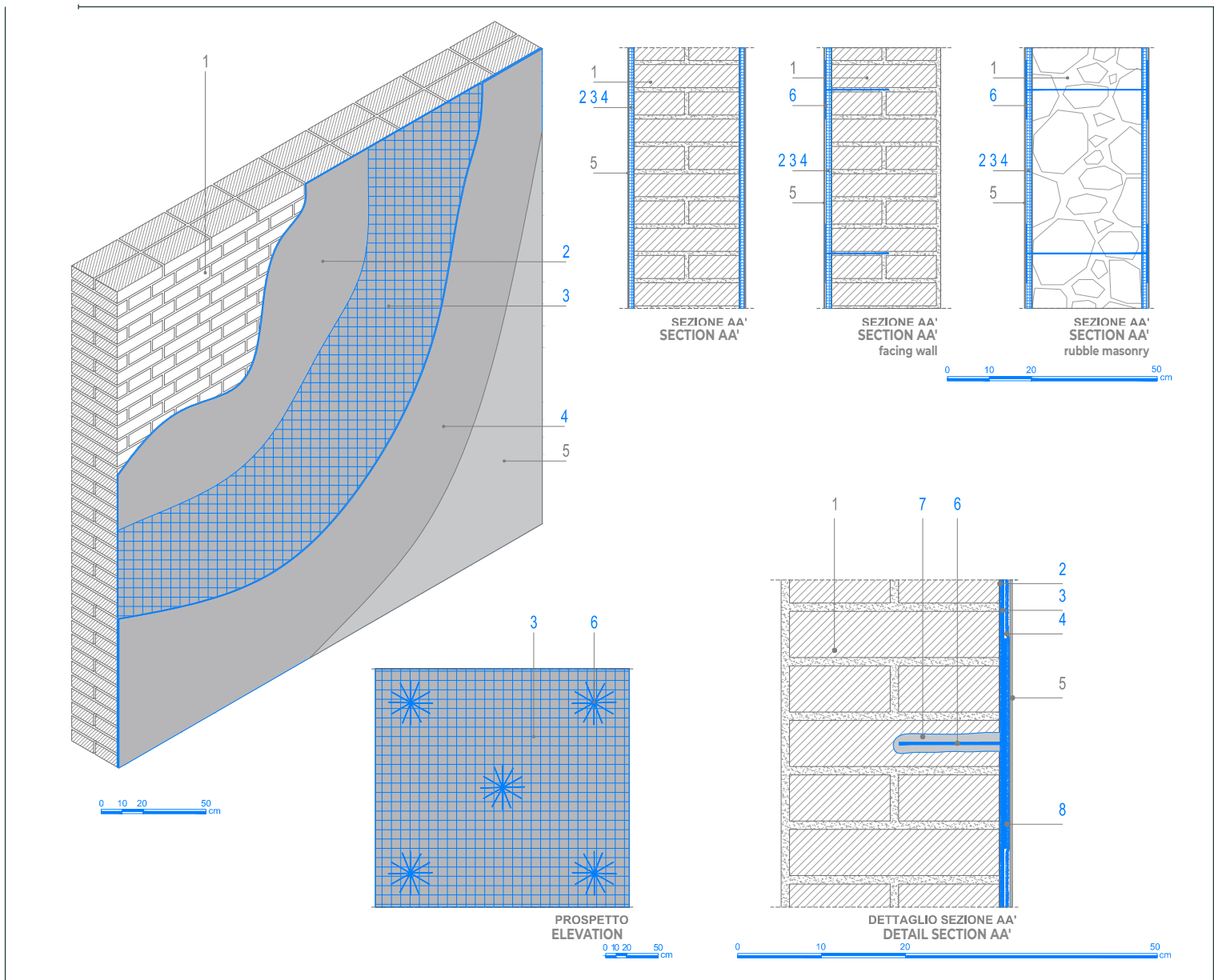

↓ NOTES

1. Depending on specific design conditions, A.R. alkali-resistant, glass fibre **MAPEGRID G 220** or basalt fibre **MAPEGRID B 250** mesh may be used.
2. **PLANITOP HDM RESTAURO** is a two-component, ready-mixed, high-ductility, natural hydraulic lime (NHL) and Eco-Pozzolan-based mortar specifically recommended for old masonry structures (listed buildings) to guarantee mechanical, physical and chemical compatibility with the materials used for the original masonry.
3. **PLANITOP HDM MAXI** is a two-component, high-ductility, fibre-reinforced mortar containing Pozzolan-reaction binders.
4. **PLANITOP HDM MAXI** complies with the requirements of EN 998-1 as GP type CS IV class render, of EN 998-2 for M25 masonry mortar and the requirements of EN 1504-3 for R2 class non-structural mortar.

SCAN THE QR CODE

To download strengthening Data sheets, Technical data sheets, DWG, structural calculation software and other useful tips

or **DOWNLOAD FROM OUR WEBSITE**
www.rinforzo-strutturale.it



STRENGTHENING OF LOAD-BEARING MASONRY

STRENGTHENING WITH REINFORCED RENDER: MAPENET EM SYSTEM

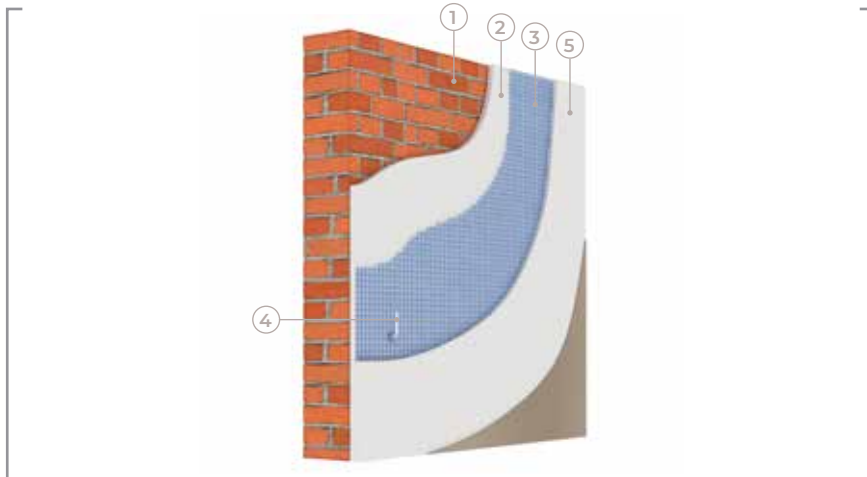

- ←
- 1 | EXISTING MASONRY
 - 2 | MAPEWALL RENDER & STRENGTHEN or MAPE-ANTIQUE STRUTTURALE NHL
 - 3 | MAPENET EM 30/40
 - 4 | MAPENET EM CONNECTOR
 - 5 | MAPEWALL RENDER & STRENGTHEN or MAPE-ANTIQUE STRUTTURALE NHL

APPLICATION PROCEDURE



“Reinforced render” is made by applying a system comprising **MAPEWALL RENDER & STRENGTHEN** one-component, ready-mixed, high-performance, fibre-reinforced, natural hydraulic lime-based mortar, which is perfectly compatible physically and mechanically with the substrate, and **MAPENET EM A.R.** alkali-resistant, pre-impregnated glass fibre mesh (FRP) to give the structure a higher level of ductility and a more even distribution of stresses and loads. After preparing the substrate and rounding off any sharp edges on the masonry to a radius of at least 20 mm, proceed as follows:

- Drill a series of 16 mm diameter holes in the masonry so that there are 4 holes per square metre (photo A).
- Clean the holes with compressed air (photo B).
- Inject **MAPEFIX EP 470 SEISMIC** or **MAPEFIX EP 385-585** epoxy chemical anchor or **MAPEFIX VE SF** vinyl ester chemical anchor into the holes (photo C).
- Insert **MAPENET EM CONNECTOR** pre-formed, “L”-shaped, alkali-resistant, glass fibre and thermo-setting resin fasteners (photo D).
- Level off the entire surface of the masonry with a layer at least 10 mm thick of **MAPEWALL RENDER & STRENGTHEN** to form a sufficiently flat surface (photo E).
- While applying the first layer of mortar, apply **MAPENET EM** structural mesh so that it sits on the “L”-shaped connectors; overlap the mesh lengthways by around 15 cm. Because the mesh is so flexible, it may be shaped and folded to suit the masonry without having to apply special pieces (photo F).
- Apply a second layer around 15 mm thick of **MAPEWALL RENDER & STRENGTHEN** (while the first layer is still fresh) so that it completely covers the strengthening package applied previously (photo G). Depending on the type of masonry to be strengthened, the design engineer may decide to apply the strengthening system on both faces or on one face only.

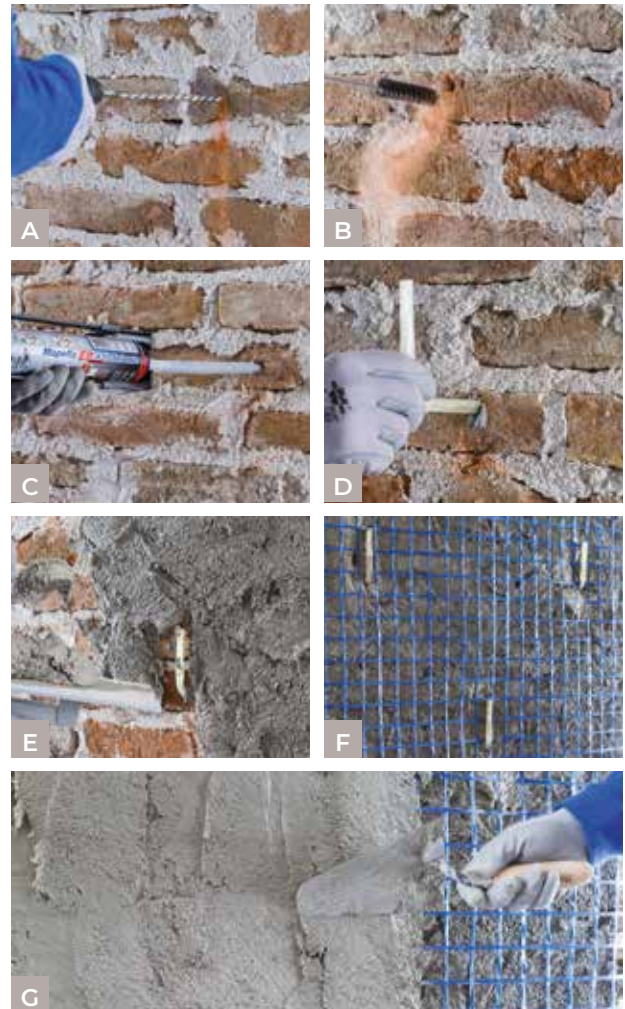

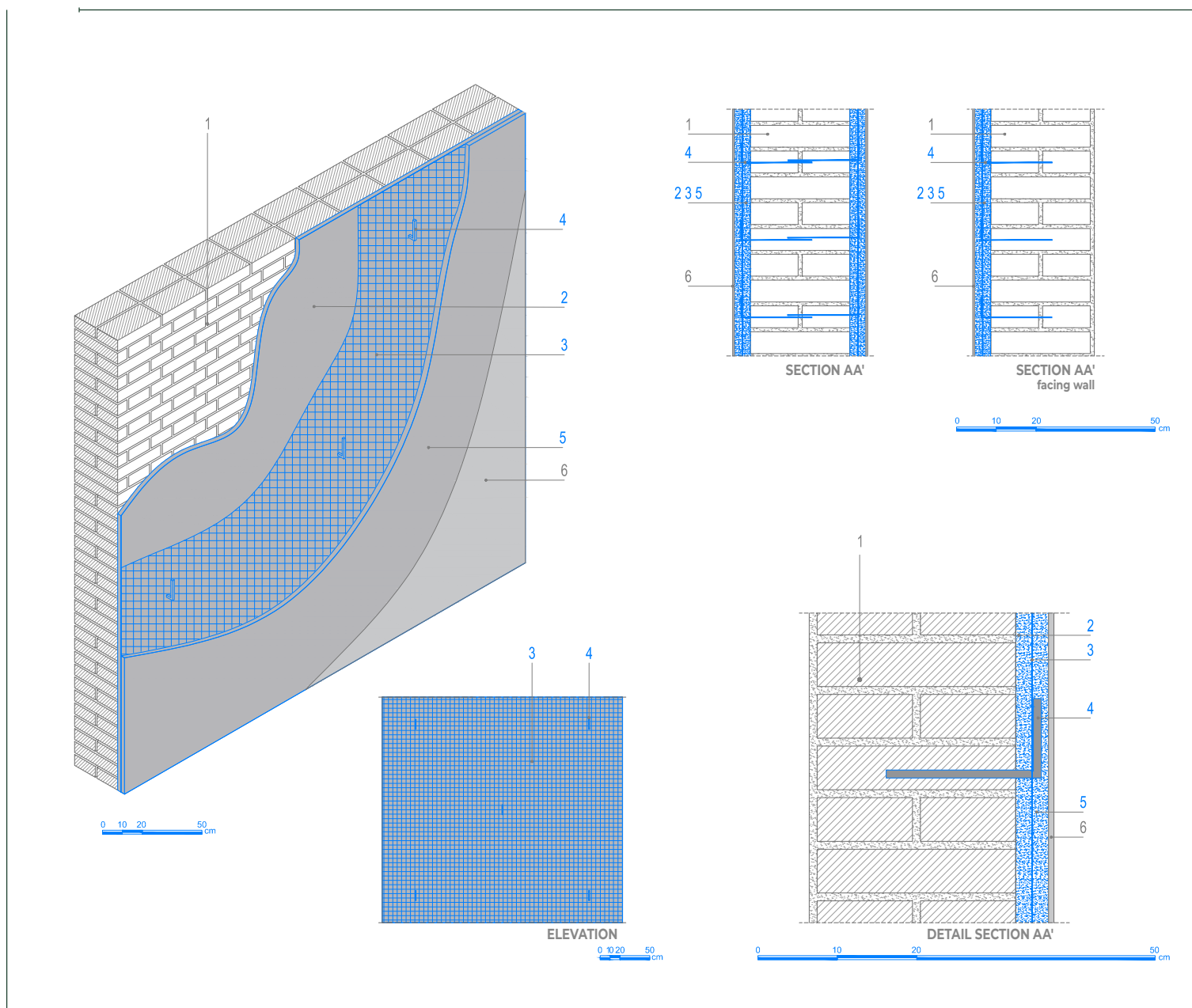

↓ NOTES

1. Depending on specific design conditions, A.R. alkali-resistant, glass fibre **MAPENET EM 30** or **MAPENET EM 40** mesh may be used.
2. **MAPENET EM CONNECTOR** available in 20 cm, 38 cm, 50 cm and 70 cm lengths.
3. As an alternative to **MAPEWALL RENDER & STRENGTHEN** it is possible to use **MAPE-ANTIQUE STRUTTURALE NHL** cement-free, natural hydraulic lime and Eco-Pozzolan-based mortar, which is specifically recommended for old (historic) masonry structures, and is guaranteed to be mechanically, physically and chemically compatible with the materials used for the original masonry.

SCAN THE QR CODE

To download strengthening Data sheets, Technical data sheets, DWG, structural calculation software and other useful tips

or **DOWNLOAD FROM OUR WEBSITE**
www.rinforzo-strutturale.it



STRENGTHENING OF MASONRY ARCHES AND VAULTS

SUBSTRATE PREPARATION BY POINTING CONSTRUCTION JOINTS

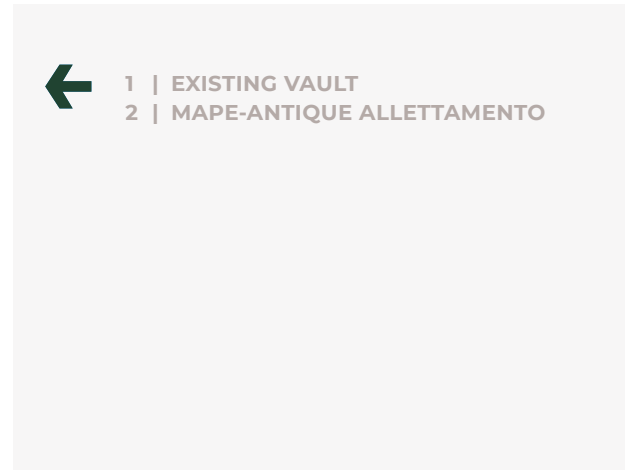
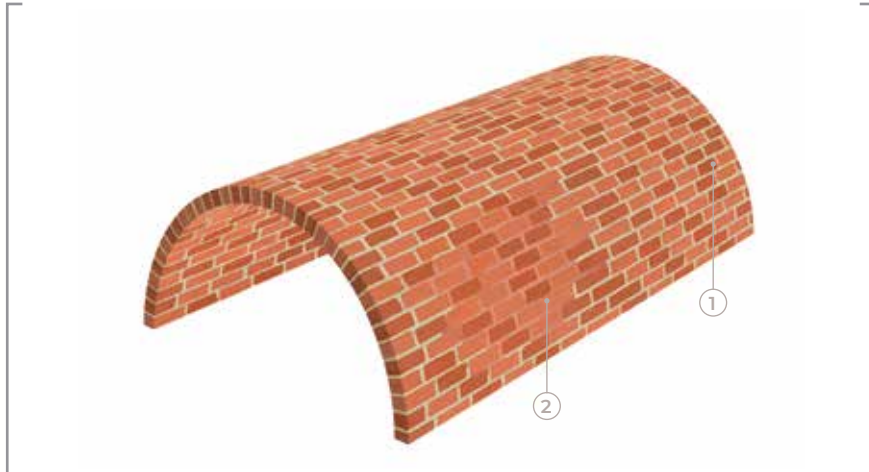

APPLICATION PROCEDURE

Before carrying out strengthening work on a vault or arch, temporary supports and/or braces need to be put in place to make the work area safe and to analyse the surfaces. Proceed as follows:

- Shore up the intrados of the vault or arch.
- Remove the spandrels and any deteriorated or detached areas until the substrate is sound, compact and strong so that the strengthening package itself does not detach.
- Scrape out any deteriorated mortar from the joints, without compromising the integrity of the wall face, to obtain a sound, compact substrate with no crumbling or unstable areas and no saline efflorescence, dust or mildew.
- Remove all loose material from the surfaces to be restored with a vacuum cleaner.
- Hydro-blast the surface to remove all traces of material and substances that could affect adhesion of the products to be applied later.
- Repoint the joints between the bricks/blocks with **MAPE-ANTIQUE ALLETTAMENTO** or **MAPEWALL MURATURA FINE** (photos A, B and C).



NOTES

1. **MAPE-ANTIQUE ALLETTAMENTO** is available in 7 colours.
2. As an alternative to **MAPE-ANTIQUE ALLETTAMENTO** it is possible to use **MAPE-ANTIQUE STRUTTURALE NHL**.
3. As an alternative to **MAPEWALL MURATURA FINE** it is also possible to use **MAPEWALL MURATURA GROSSO** and **MAPEWALL RENDER & STRENGTHEN**.

STRENGTHENING OF MASONRY ARCHES AND VAULTS CONSOLIDATION AND STRENGTHENING BY INJECTING HYPER-FLUID SLURRY

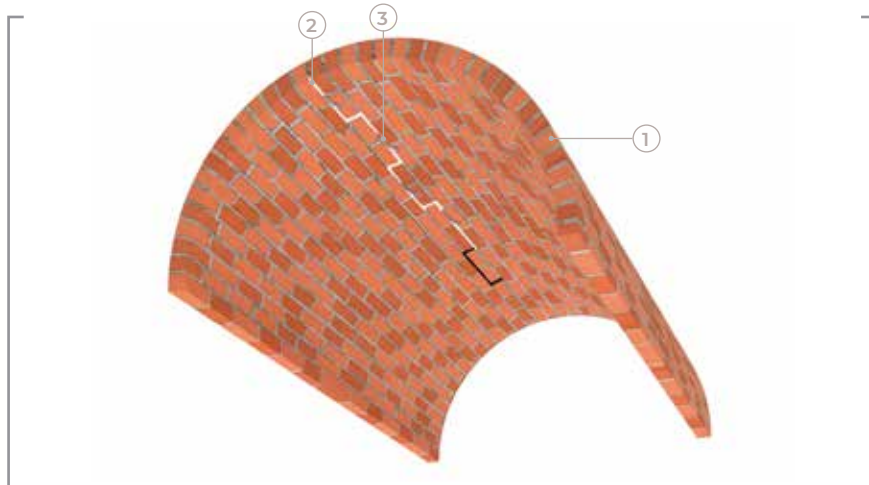

APPLICATION PROCEDURE



Cracks in vaults and arches may be consolidated on both the intrados and the extrados by injecting them with hyper-fluid, volumetrically-stable slurry resistant to salt with a hand or electronic pump or by gravity filling as follows:

- Prepare the substrate by grouting and “sealing” any cracks and gaps in the bricks/blocks of the vault or arch from which the slurry could seep out with **MAPE-ANTIQUE ALLETTAMENTO** or **MAPEWALL MURATURA FINE**.
- Drill a series of 20-40 mm diameter holes.
- Fasten tubes or injectors in the holes with **MAPE-ANTIQUE ALLETTAMENTO** or **MAPEWALL MURATURA FINE** to inject slurry made from **MAPE-ANTIQUE I-15** or **MAPEWALL INJECT & CONSOLIDATE** (photos A and B).
- The day before injecting the slurry, saturate all the inside of the structure with water through the tubes or injectors previously fastened in place. Make sure the structure has absorbed all the water before injecting the slurry, which must be carried out starting at the bottom of the wall working upwards (photo C).
- Remove the tubes or injectors and grout the holes with **MAPE-ANTIQUE ALLETTAMENTO** or **MAPEWALL MURATURA FINE** (photo D).

NOTES

- MAPE-ANTIQUE I-15 is a cement-free, salt-resistant, fillerized, lime and Eco-Pozzolan-based hydraulic binder for making super-fluid injectable slurry for consolidating masonry and is specifically recommended for old masonry structures (listed buildings) to guarantee mechanical, physical and chemical compatibility with the materials used for the original masonry.*
- As an alternative to MAPE-ANTIQUE I-15 it is possible to use MAPE-ANTIQUE I or MAPE-ANTIQUE F21.*
- MAPEWALL INJECT & CONSOLIDATE is a natural hydraulic lime-based, reactive inorganic binder with very low emission of VOC for making super-fluid injectable slurry for consolidating masonry.*

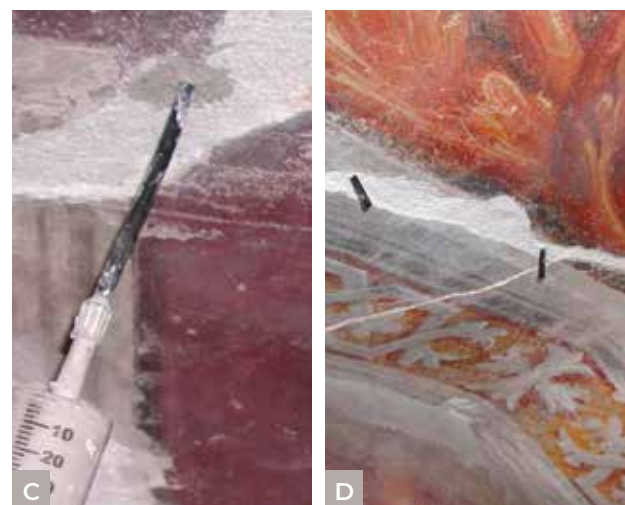
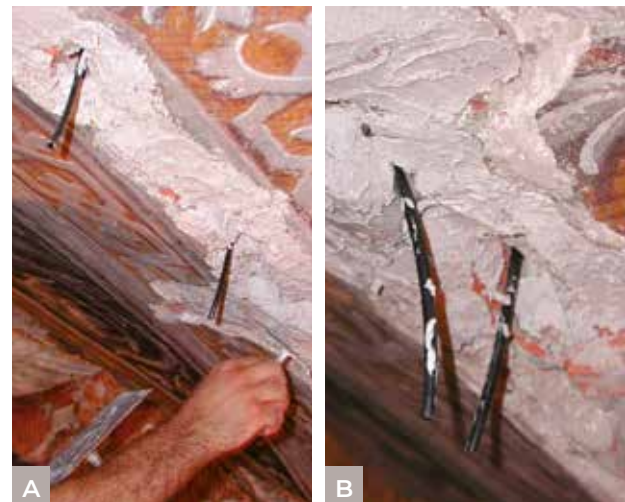

STRENGTHENING OF MASONRY ARCHES AND VAULTS CLADDING WITH FRP: MAPEWRAP SYSTEM FABRICS

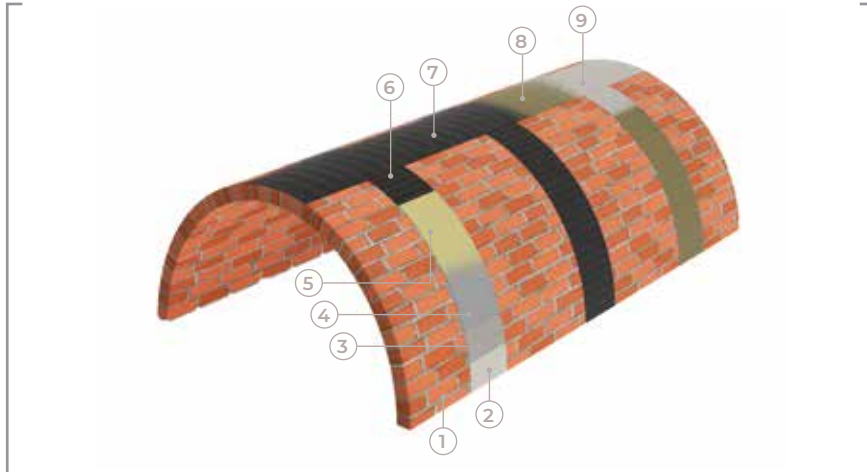

- ←
- 1 | EXISTING VAULT
 - 2 | PLANITOP HDM MAXI or PLANITOP HDM RESTAURO
 - 3 | MAPEWRAP PRIMER 1
 - 4 | MAPEWRAP 11/12
 - 5 | MAPEWRAP 31
 - 6 | MAPEWRAP UNI-AX
 - 7 | MAPEWRAP C QUADRI-AX
 - 8 | MAPEWRAP 31
 - 9 | QUARTZ 1.2

APPLICATION PROCEDURE

A vault or an arched element may be structurally strengthened on the extrados or intrados by applying **FRP SYSTEM** fabrics. After **preparing the substrate** strengthen the vault or arch along its axes as follows.

If the surface to be strengthened is particularly uneven, it is recommended to skim the surface along the axes of the vault or arch with a sufficiently flat layer 5-6 mm thick of **PLANITOP HDM MAXI** or **PLANITOP HDM RESTAURO** two-component, high-ductility, fibre-reinforced mortar. Once the mortar has cured, apply the **MAPEWRAP** fabric as follows:

- Apply **MAPEWRAP PRIMER 1** two-component epoxy primer on the surfaces to be strengthened (photo A).
- While the primer is still fresh, apply an even layer 1.0-1.5 mm thick of **MAPEWRAP 11** or **MAPEWRAP 12** two-component epoxy putty with a trowel (*) (photo B).
- While the epoxy grout is still fresh, apply a layer of **MAPEWRAP 31** fluid epoxy resin to impregnate the fabric (photo C).
- Cut the **MAPEWRAP** fabric to the length required with scissors.
- Apply the **MAPEWRAP UNI-AX** or **MAPEWRAP C QUADRI-AX** on the resin and go over it with a **MAPEWRAP ROLLER** to eliminate any air bubbles (photos D and E).
- Apply a second layer of **MAPEWRAP 31** (photo F).
- Broadcast the resin while still fresh with dry **QUARTZ 1.2** sand (photo G).

Apply a series of strategically placed connectors made from **MAPEWRAP FIOCCO** around the springers of the arch or vault so that they are attached to the strengthening package (SHEET 6.F). The connectors eliminate any “de-bonding” phenomenon and increase the static efficiency of the strengthening package applied.

(*) If a longer workability time is required use **MAPEWRAP 12**.



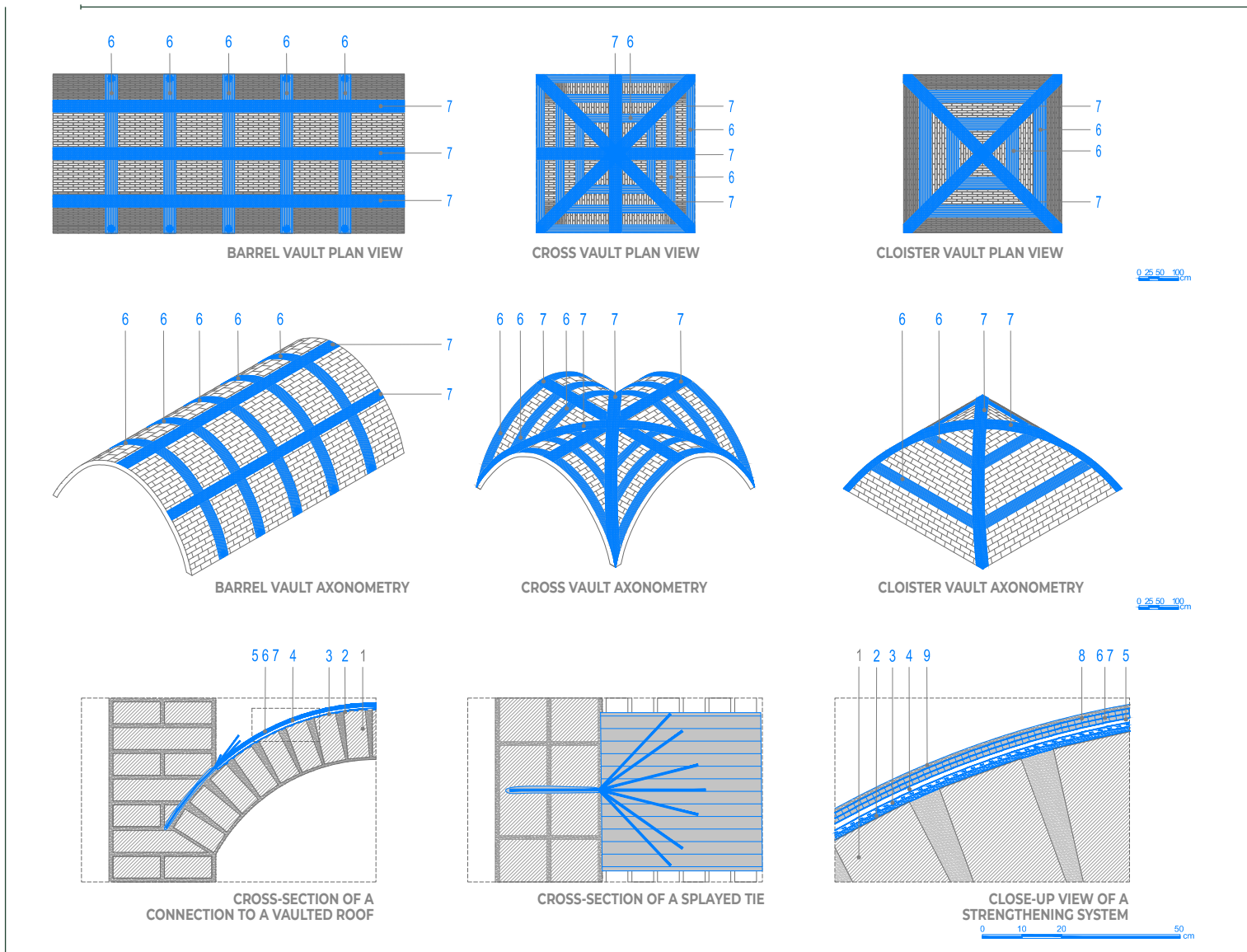

↓ NOTES

1. Depending on design requirements, the design engineer can choose between **MAPEWRAP C UNI-AX** unidirectional carbon fibre fabric, **MAPEWRAP G UNI-AX** glass fibre fabric or **MAPEWRAP B UNI-AX** basalt fibre fabric, which are all available in various weights.
2. **PLANITOP HDM RESTAURO** is a two-component, ready-mixed, high-ductility, natural hydraulic lime (NHL) and Eco-Pozzolan-based mortar specifically recommended for old masonry structures (listed buildings) to guarantee mechanical, physical and chemical compatibility with the materials used for the original masonry.
3. **PLANITOP HDM RESTAURO** complies with the requirements of EN 998-1 and EN 998-2 for M15 masonry mortar.
4. **PLANITOP HDM MAXI** is a two-component, high-ductility, fibre-reinforced mortar containing Pozzolan-reaction binders.
5. **PLANITOP HDM MAXI** complies with the requirements of EN 998-1 as GP type CS IV class render, of EN 998-2 for M25 masonry mortar and the requirements of EN 1504-3 for R2 class non-structural mortar.

SCAN THE QR CODE

To download strengthening Data sheets, Technical data sheets, DWG, structural calculation software and other useful tips

or **DOWNLOAD FROM OUR WEBSITE**
www.rinforzo-strutturale.it



STRENGTHENING MASONRY ARCHES AND VAULTS

STRENGTHENING WITH LOW THICKNESS REINFORCED RENDER: FRCM SYSTEM

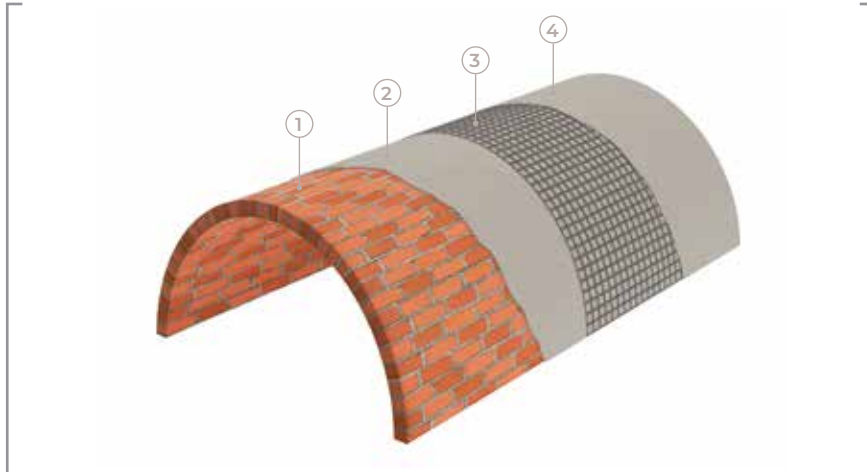

- 1 | EXISTING VAULT
- 2 | PLANITOP HDM MAXI or PLANITOP HDM RESTAURO
- 3 | MAPEGRID G 220 or MAPEGRID B 250
- 4 | PLANITOP HDM MAXI or PLANITOP HDM RESTAURO

APPLICATION PROCEDURE



A vault or an arched element may be structurally strengthened on the extrados or intrados by applying mesh from the **FRCM SYSTEM (MAPEGRID B 250 or MAPEGRID G 220)** in combination with two-component, high-ductility, fibre-reinforced mortar (**PLANITOP HDM MAXI** or **PLANITOP HDM RESTAURO**). After preparing the substrate (SHEETS 7.A and 7.B) and removing the render, consolidate and strengthen the vault or arch as follows:

- Level off the entire surface of the intrados/extrados of the vault or arch, including any counter-arches or buttresses on the extrados, with a sufficiently flat layer 5-6 mm thick of two-component, high-ductility, fibre-reinforced mortar (**PLANITOP HDM MAXI** or **PLANITOP HDM RESTAURO**) (photo A).
- Apply **MAPEGRID G 220** A.R. alkali-resistant structural glass fibre mesh or **MAPEGRID B 250** basalt fibre mesh on the mortar while it is still fresh and run the strengthening package along the vertical walls for at least 40 cm. Apply the pieces of mesh alongside each other and overlap them by around 15 cm (photo B).
- Apply a second layer 5-6 mm thick of **PLANITOP HDM MAXI** or **PLANITOP HDM RESTAURO** over the entire surface of the vault or arch while the first layer is still fresh so that it completely covers the mesh (photos C and D).
- Apply a series of strategically placed connectors made from **MAPEWRAP FIOCCO** around the springers of the arch or vault so that they are attached to the strengthening package (SHEET 8.A). The connectors eliminate any “de-bonding” phenomenon and increase the static efficiency of the strengthening package applied (photo E).



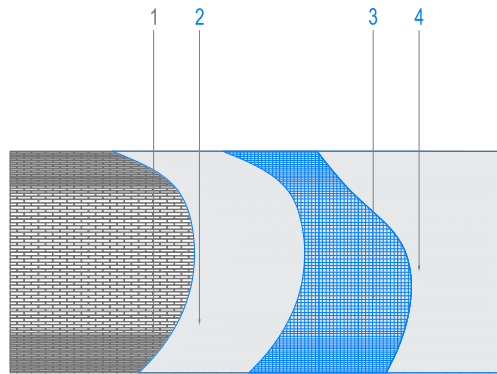

BARREL VAULT PLAN VIEW

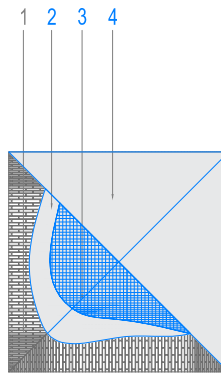

CROSS VAULT PLAN VIEW

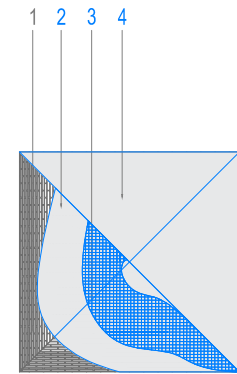

CLOISTER VAULT PLAN VIEW

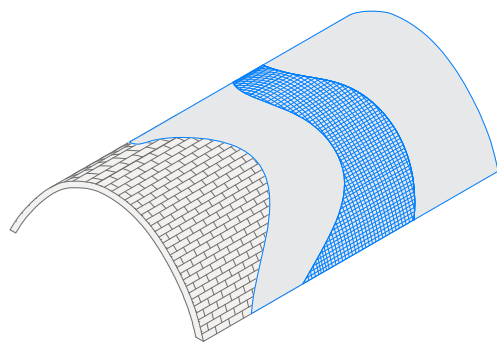

BARREL VAULT AXONOMETRY

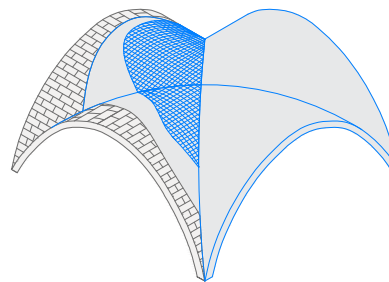

CROSS VAULT AXONOMETRY

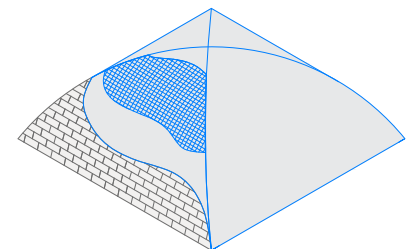

CLOISTER VAULT AXONOMETRY

0 25 50 100 cm

↓ NOTES

1. Depending on specific design conditions, A.R. alkali-resistant, glass fibre **MAPEGRID G 220** or basalt fibre **MAPEGRID B 250** mesh may be used.
2. **PLANITOP HDM RESTAURO** is a two-component, ready-mixed, high-ductility, natural hydraulic lime (NHL) and Eco-Pozzolan-based mortar specifically recommended for old masonry structures (listed buildings) to guarantee mechanical, physical and chemical compatibility with the materials used for the original masonry.
3. **PLANITOP HDM MAXI** is a two-component, high-ductility, fibre-reinforced mortar containing Pozzolan-reaction binders.
4. **PLANITOP HDM MAXI** complies with the requirements of EN 998-1 as GP type CS IV class render, of EN 998-2 for M25 masonry mortar and the requirements of EN 1504-3 for R2 class non-structural mortar.

SCAN THE QR CODE

To download strengthening Data sheets, Technical data sheets, DWG, structural calculation software and other useful tips

or **DOWNLOAD FROM OUR WEBSITE**
www.rinforzo-strutturale.it



COMPLEMENTARY SYSTEMS

TRANSVERSAL CONNECTORS MADE FROM MAPEWRAP FIOCCO

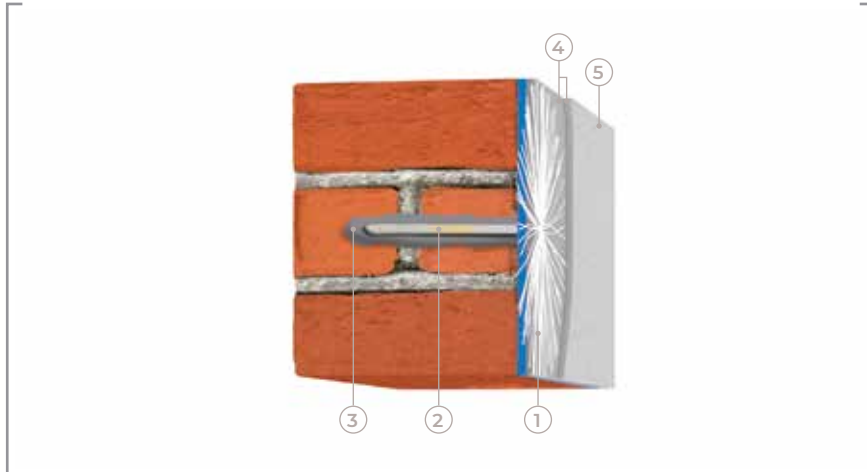

- ←
- 1 | MAPEWRAP FIOCCO
 - 2 | MAPEWRAP 21 + QUARTZ 1.2
 - 3 | MAPEFIX VE SF, EP 385/585 or EP 470 SEISMIC
 - 4 | MAPEWRAP 11 or MAPEWRAP 31
 - 5 | QUARTZ 1.2

APPLICATION PROCEDURE

To guarantee that a strengthening system applied on load-bearing walls is more effective, special connectors can be made from **MAPEWRAP FIOCCO**. The connectors are made from special cord and may be through-type or surface-type, depending on the design specifications and the type of masonry.

To make **surface-type connectors** proceed as follows:

- Cut **MAPEWRAP FIOCCO** (C, G or B) cord to a length equal to the depth of the hole plus the length of the end part to be splayed out on the surface (photo A).
- Impregnate the part to be inserted in the hole with **MAPEWRAP 21** fluid epoxy resin (photo B).
- Broadcast the surface of the part of the connector impregnated with resin with dry **QUARTZ 1.2** sand. Wait around 24 hours and, once the resin has set, position the connectors as specified (photo C).

To make **through-type connectors** proceed as follows:

- Cut **MAPEWRAP FIOCCO** (C, G or B) cord to a length equal to the thickness of the masonry plus the length of the two ends to be splayed out on the surface (photo D).
- Impregnate the central part of the cord with **MAPEWRAP 21** fluid epoxy resin (photos E and F).
- Broadcast the surface of the part of the connector impregnated with resin with dry **QUARTZ 1.2** sand.
- Wait around 24 hours and, once the resin has set, position the connectors as specified (photo H).

Positioning the connectors

Once the mortar for the system to be connected has cured, proceed as follows:

- Inject **MAPEFIX EP 470 SEISMIC** or **MAPEFIX EP 385-585** epoxy chemical anchor or **MAPEFIX VE SF** vinyl ester chemical anchor into the holes (photo I).
- Insert the rigid part of the anchoring connectors into the holes (photo J).
- Splay out the ends of the connectors over the strengthening package applied previously and fasten them in place with **MAPEWRAP 11** (or **MAPEWRAP 12**) or **MAPEWRAP 31** (photo K).
- Broadcast the splayed ends of the cord with dry **QUARTZ 1.2** sand (photo L).



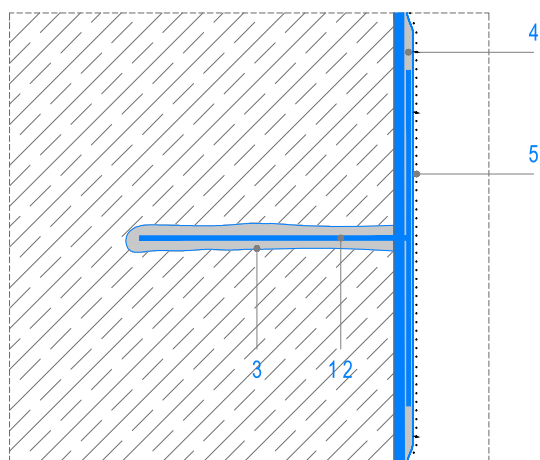

CLOSE-UP VIEW OF A BLIND TIE

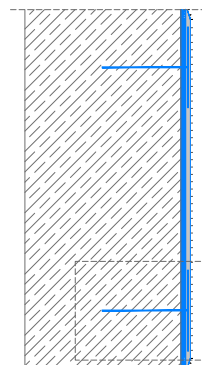

BLIND TIE

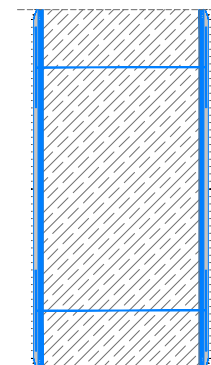

THROUGH-TIE

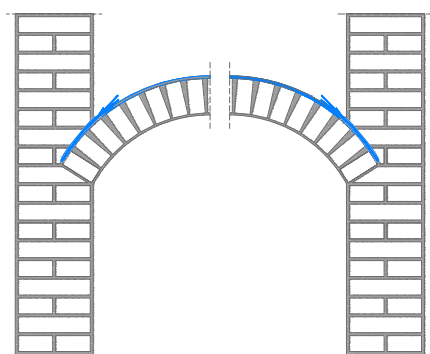

CONNECTION TO A VAULTED ROOF

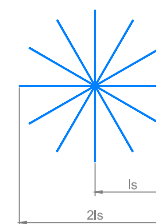
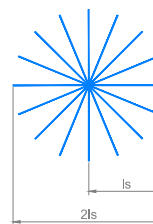
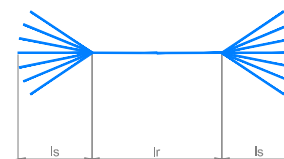
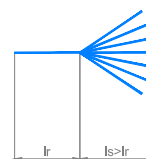

l_r = length of rigid part
 l_s = splayed length

NOTES

1. The number, type, diameter and size of the MAPEWRAP FIOCCO transversal connectors must be defined during the design phase.

SCAN THE QR CODE

To download strengthening Data sheets, Technical data sheets, DWG, structural calculation software and other useful tips

or **DOWNLOAD FROM OUR WEBSITE**
www.rinforzo-strutturale.it



FLEXURAL STRENGTHENING OF WOODEN FLOOR BEAMS AND JOISTS

SUBSTRATE PREPARATION AND CONSOLIDATION OF WOODEN ELEMENTS

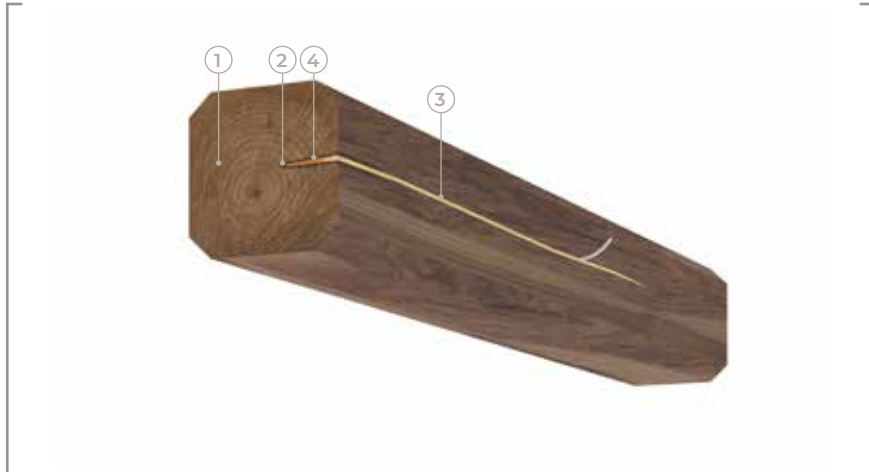

- 1 | EXISTING WOODEN BEAM/JOIST
- 2 | MAPEWOOD PRIMER 100
- 3 | MAPEWOOD PASTE 140
- 4 | MAPEWOOD GEL 120

APPLICATION PROCEDURE



The static efficiency of wooden elements can be reinstated with fibre-reinforced composite materials (FRP) once the substrates have been prepared correctly and any areas with cracks have been consolidated.

SUBSTRATE PREPARATION

- Clean the wooden element to remove any weak or loose areas to create a substrate that is sound, compact and mechanically strong so that the materials to be applied do not become detached (photo A).
- Vacuum the substrate to remove any traces or residues of loose material.

SEALING THE CRACKS

If there are cracks in the surface and/or other cracks or damage that go deeper into the element, proceed as follows:

- Apply a coat of **MAPEWOOD PRIMER 100** fluid epoxy impregnator in water dispersion with a high level of chemical and physical compatibility with wood.
- Seal the cracks in the surface by applying **MAPEWOOD PASTE 140** two-component thixotropic adhesive with a metal trowel (photos B and C).
- For deeper and more serious cracks or damage to wooden elements, inject **MAPEWOOD GEL 120** epoxy gel adhesive to stop the surface of the element detaching and to fill any gaps or breaks in the element.



 **NOTES**

1. The **MAPEWOOD** Range by Mapei is a range of specific impregnators and epoxy resins specially formulated for consolidating wooden elements.

FLEXURAL STRENGTHENING OF WOODEN FLOOR BEAMS AND JOISTS

FLEXURAL STRENGTHENING BY CLADDING WITH CARBOPLATE SYSTEM CARBON FIBRE PLATES

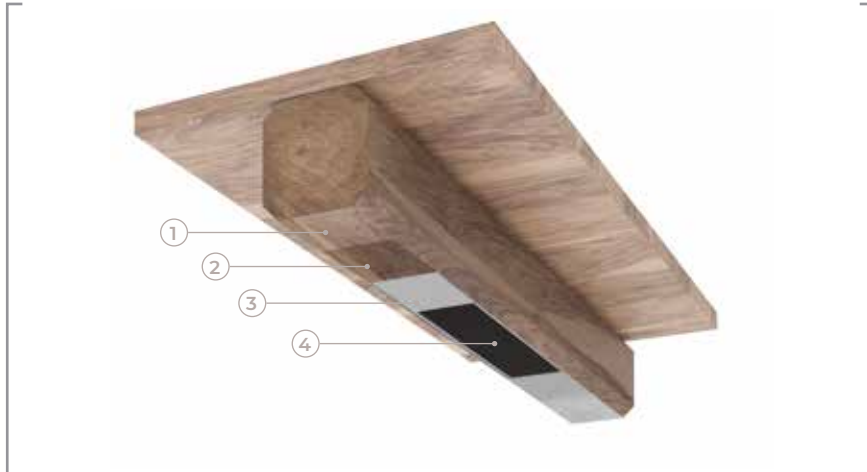

- ←
- 1 | EXISTING WOODEN BEAM/JOIST
 - 2 | MAPEWRAP PRIMER 1
 - 3 | MAPEWRAP 11/12
 - 4 | CARBOPLATE

APPLICATION PROCEDURE



Flexural strengthening for the beams and joists of wooden floors may be carried out by bonding **CARBOPLATE** pultruded carbon fibre plates with epoxy resin along the intrados of the beams or joists (photo A) or in pockets or vertical slits cut crossways or along the sides of the elements.

Proceed as follows:

- Apply a coat of **MAPEWRAP PRIMER 1** two-component epoxy primer on the surface to be strengthened on the intrados of the elements or on the surface of the pockets or slots (photo B).
- While the primer is still fresh, apply an even layer 1.0-1.5 mm thick of **MAPEWRAP 11** or **MAPEWRAP 12** (*) two-component thixotropic epoxy adhesive with a trowel (photo C).
- Cut **CARBOPLATE** to the length required with a hand-grinder.
- Remove the protective (peel-ply) film from the plates and apply **MAPEWRAP 11** or **MAPEWRAP 12** with a trowel on one side of the plates, or on both sides if they are to be inserted in special pockets or slots (photo D).
- Insert **CARBOPLATE** plates into the pockets or slots or along the intrados of the wooden element (photo E).
- Go over the plates with a **MAPEWRAP ROLLER** to eliminate any air bubbles (photo F).

(*) If a longer workability time is required use **MAPEWRAP 12**.

It is possible to complete the intervention by applying another coat of **MAPEWRAP 11** or **MAPEWRAP 12** on the intrados of the **CARBOPLATE** plates, broadcasting the resin with dry **QUARTZ 1.2** sand and then covering the strengthening package with a suitable finishing product or a wooden feature.

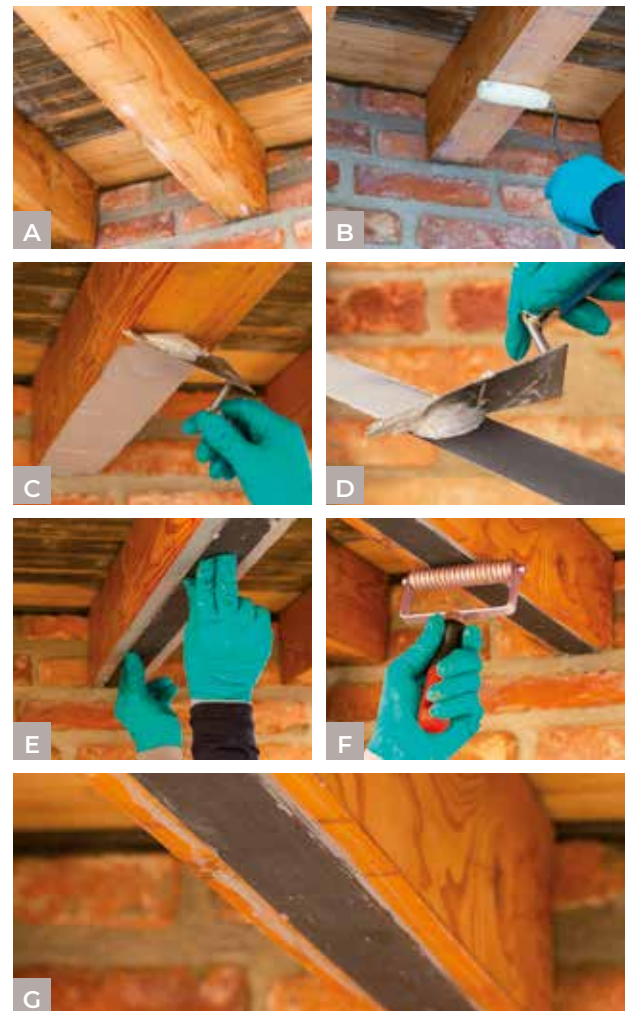

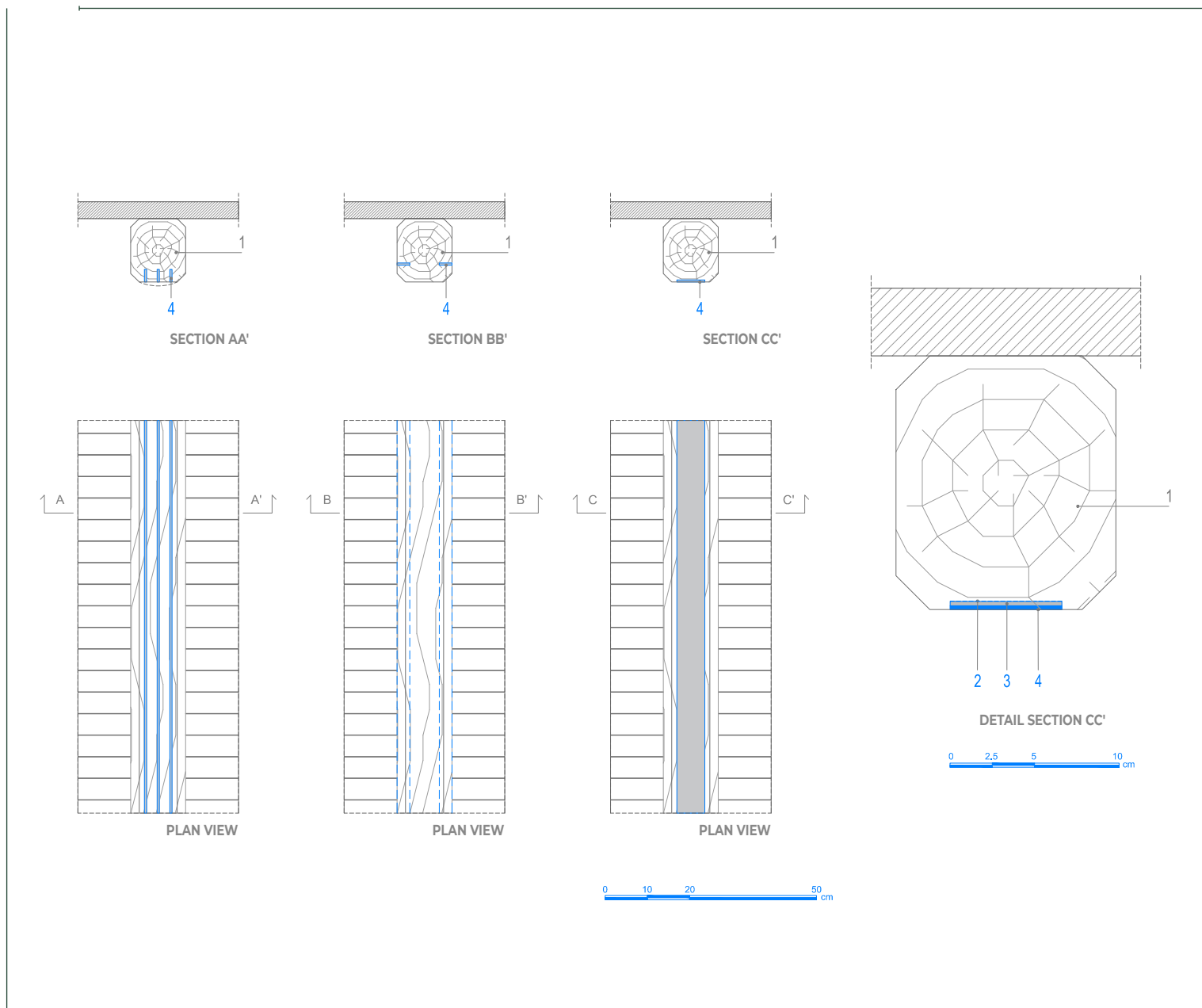

↓ NOTES

1. To design the strengthening package, follow the instructions in CNR DT 201/2005, "Guidelines for the Static Consolidation of Wooden Structures with Fibre-reinforced Composites".
2. If more than one layer of plates is applied (we recommend no more than three) they must be placed directly on the layer **MAPEWRAP 11** or **MAPEWRAP 12** while it is still fresh.
3. **CARBOPLATE SYSTEM** is covered by Technical Evaluation Certificate (CVT) according to guideline No. 220, 09/07/2015 issued by the Supreme Council of Public Works.

SCAN THE QR CODE

To download strengthening Data sheets, Technical data sheets, DWG, structural calculation software and other useful tips

or **DOWNLOAD FROM OUR WEBSITE**
www.rinforzo-strutturale.it



FLEXURAL STRENGTHENING OF WOODEN FLOOR BEAMS AND JOISTS

FLEXURAL STRENGTHENING BY INSERTING MAPEROD RODS



- ←
- 1 | EXISTING WOODEN BEAM/JOIST
 - 2 | MAPEWOOD PRIMER 100
 - 3 | MAPEWOOD PASTE 140
 - 4 | MAPEROD C/G
 - 5 | MAPEWOOD PASTE 140

APPLICATION PROCEDURE



Flexural strengthening for beams and joists for wooden floors may be carried out by inserting **MAPEROD C** or **G** pultruded carbon fibre or glass fibre bars with epoxy resin on the intrados of the beams or joists and/or in pockets made along the side of the wooden elements.

Proceed as follows:

- Make a series of pockets for the bars along the side and/or on the intrados of the wooden element with a cutter. The size and length of the pockets must be defined by the design engineer after calculating the size of the strengthening package.
- Prime the internal surface of the pockets with **MAPEWOOD PRIMER 100** two-component epoxy impregnator in water dispersion (photo A).
- Cut the **MAPEROD** to the length required with a hand-grinder.
- Fill the pockets with **MAPEWOOD PASTE 140** thixotropic epoxy adhesive (photo B).
- Insert the pieces of **MAPEROD** in the pockets (photo C).
- Remove any excess resin that has seeped out of the pockets with a trowel (photos D and E).

Broadcast the surface of the resin in the pockets with **QUARTZ 1.2** sand so that it may then be painted in a colour similar to the wooden element. Alternatively, apply slats made from the original wood over the resin while it is still fresh (in this case the depth of the cuts in the element must also take into consideration the thickness of the slats).

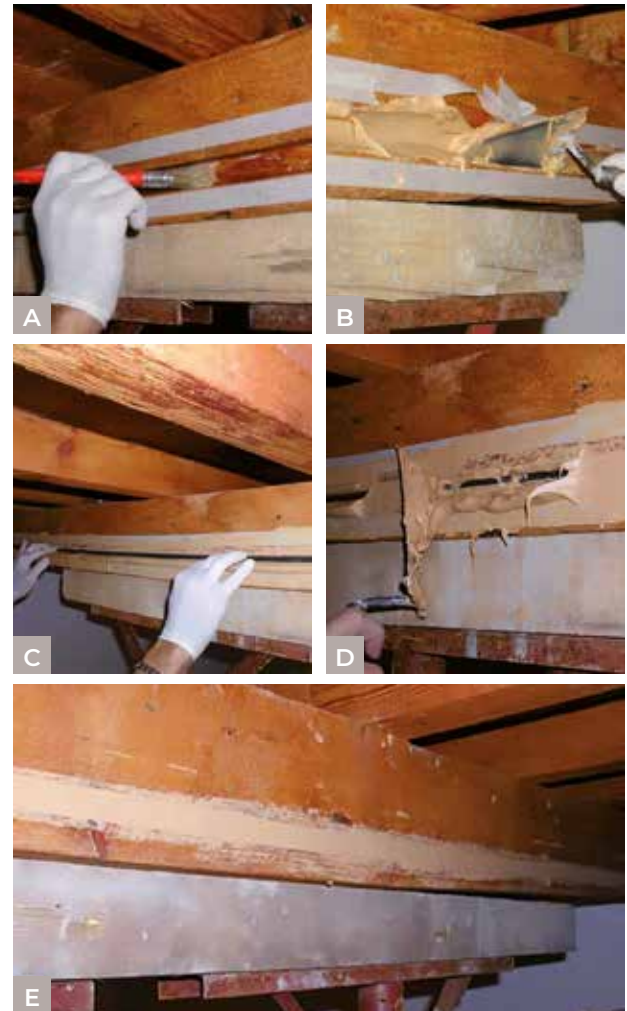

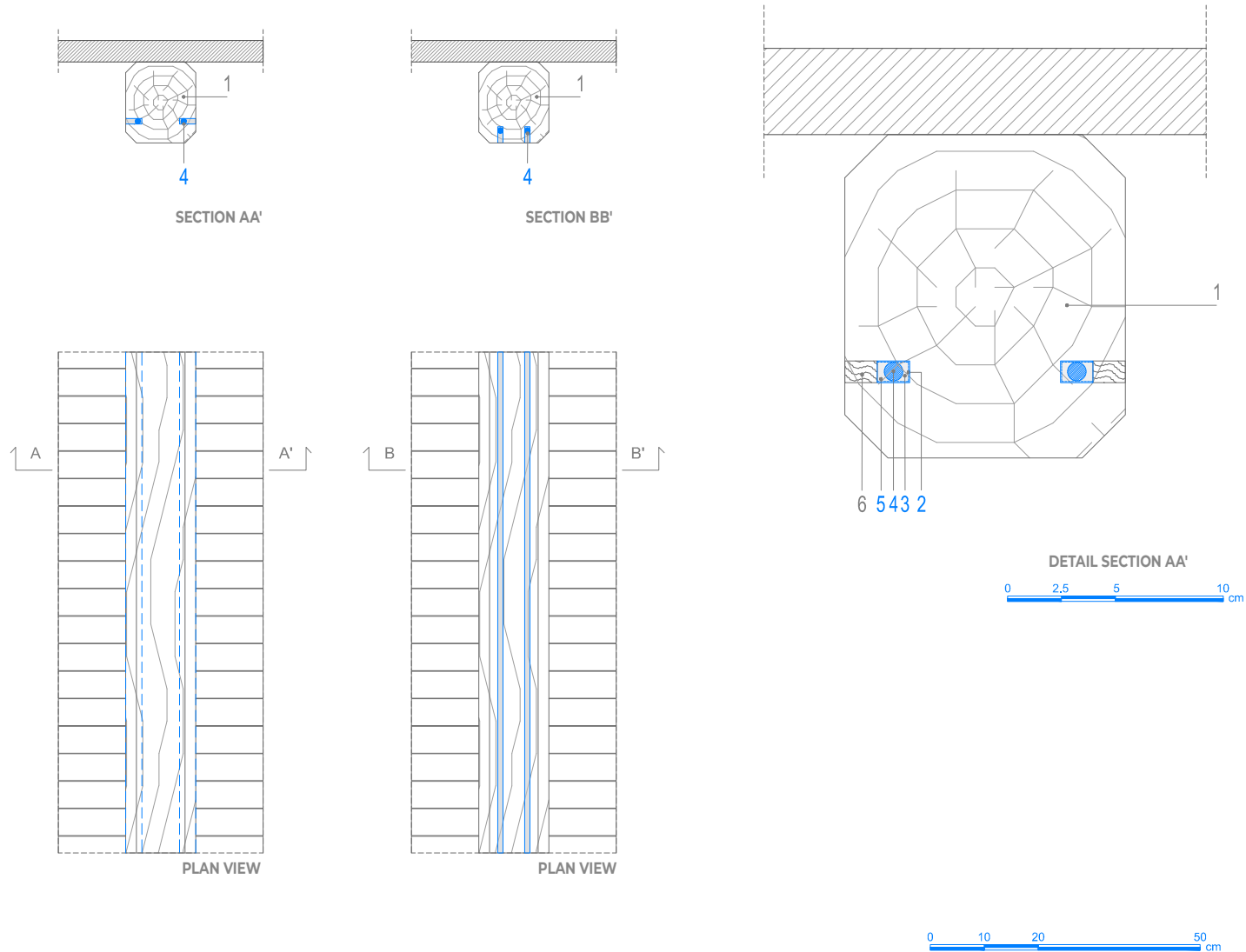

↓ NOTES

1. To design the strengthening package, follow the instructions in CNR DT 201/2005, "Guidelines for the Static Consolidation of Wooden Structures with Fibre-reinforced Composites".
2. **MAPEROD C** pultruded carbon fibre rods or **MAPEROD G** pultruded glass fibre rods impregnated with vinyl ester resin may be used, depending on design specifications.

SCAN THE QR CODE

To download strengthening Data sheets, Technical data sheets, DWG, structural calculation software and other useful tips

or **DOWNLOAD FROM OUR WEBSITE**
www.rinforzo-strutturale.it



FLEXURAL STRENGTHENING OF WOODEN FLOOR BEAMS AND JOISTS RECONSTRUCTING DAMAGED ENDS AND STRUCTURAL ELEMENTS IN WOOD

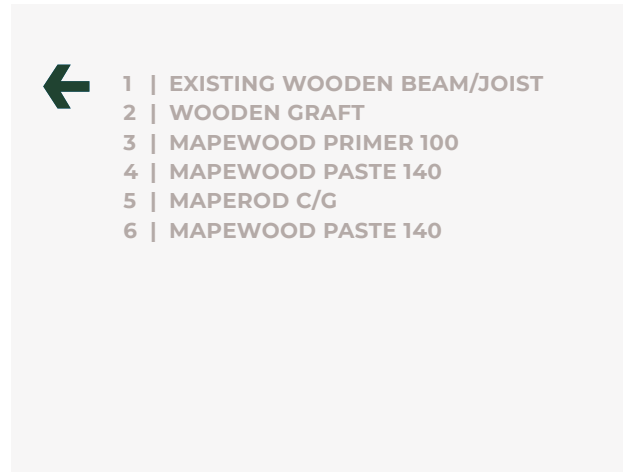

APPLICATION PROCEDURE



A new piece of beam can be grafted to an old beam by inserting **MAPEROD C** pultruded carbon fibre or **MAPEROD G** pultruded glass fibre rods inserted in pockets along the sides of the beam.

Proceed as follows:

- Make pockets according to the dimensions required to suit the bars along the sides of the wooden elements (photo A).
- Prime the internal surface of the pockets with **MAPEWOOD PRIMER 100** two-component epoxy impregnator in water dispersion.
- Cut **MAPEROD** to the length required with a hand-grinder.
- Fill the pockets with **MAPEWOOD PASTE 140** thixotropic epoxy adhesive.
- Insert the pieces of **MAPEROD** in the pockets (photo B).
- Remove any excess resin that has seeped out of the pockets with a trowel. Broadcast the surface of the resin in the pockets with **QUARTZ 1.2** sand so that it may then be painted in a colour similar to the wooden element. Alternatively, apply slats made from the original wood over the resin while it is still fresh (in this case the depth of the cuts in the element must also take into consideration the thickness of the slats) (photos C, D and E).

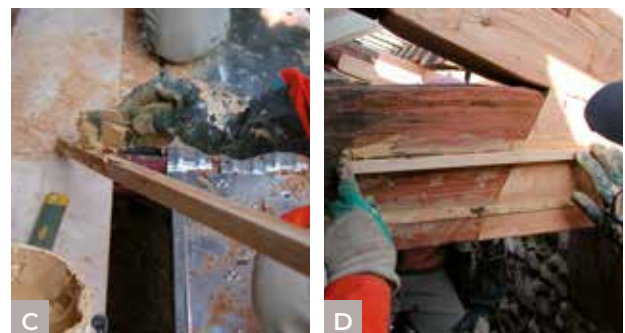

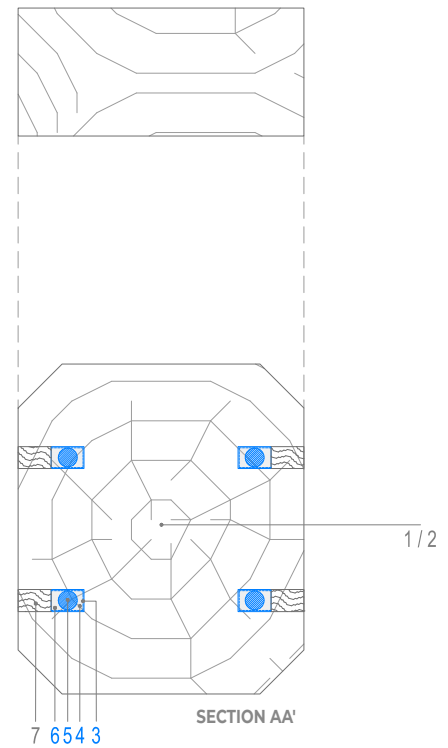
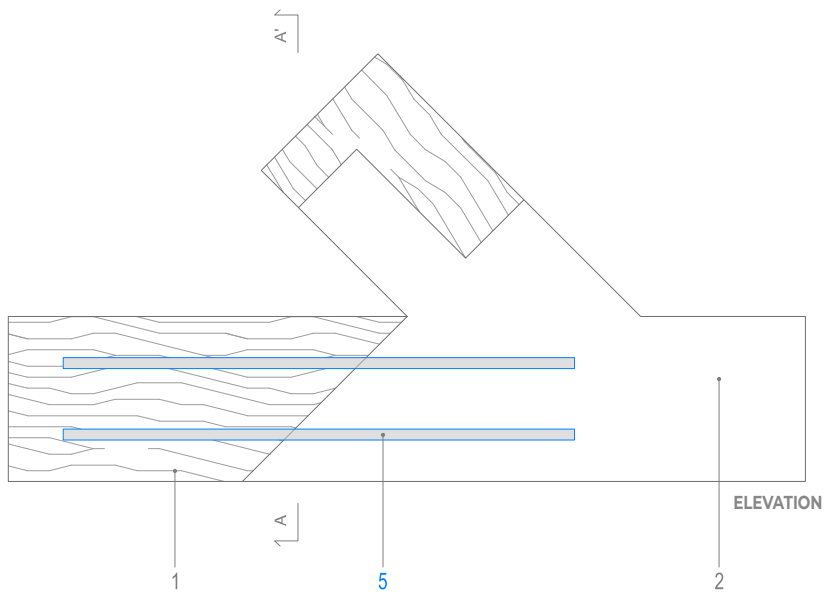

↓ NOTES

1. *MAPEROD C* pultruded carbon fibre rods or *MAPEROD G* pultruded glass fibre rods impregnated with vinyl ester resin may be used, depending on design specifications.

SCAN THE QR CODE

To download strengthening Data sheets, Technical data sheets, DWG, structural calculation software and other useful tips

or **DOWNLOAD FROM OUR WEBSITE**
www.rinforzo-strutturale.it



STRENGTHENING OF THE EXTRADOS OF FLOOR SLABS WITH A LOW THICKNESS STRUCTURAL SCREED

STRENGTHENING WOODEN FLOOR SLABS WITH HPC SYSTEM

STRUCTURAL SCREED: PLANITOP HPC FLOOR



- ←
- 1 | WOODEN JOIST
 - 2 | WOODEN PLANK
 - 3 | POLYETHYLENE SHEET or MICROPOROUS FABRIC
 - 4 | PLANITOP HPC FLOOR or PLANITOP HPC FLOOR T
 - 5 | MAPEI STEEL DRY 304

APPLICATION PROCEDURE



Wooden floors may be strengthened by applying a low thickness structural screed made from **PLANITOP HPC FLOOR** or **PLANITOP HPC FLOOR T**.

SUBSTRATE PREPARATION

Prepare the surfaces to be strengthened as follows:

- Remove all flooring and loose material.
- Place polyethylene sheets or microporous fabric of an appropriate thickness on the surface. When placing the sheets or fabric they must overlap by 10 cm so they may be sealed with adhesive tape. If necessary, fasten the sheets or fabric in place with nails or staples to prevent the mortar dripping onto the floor below.
- Insert steel rebars into holes drilled into the wall around the floor, parallel to the wooden joists, and anchor them in place with **MAPEFIX VE SF**.

STATIC STRENGTHENING FOR FLOOR SLABS

- Insert a series of 10 mm diameter **MAPEI STEEL DRY AISI 304** bars into the wooden beams (photo A). This operation is required in order to connect the existing wooden beams to **PLANITOP HPC FLOOR** or **PLANITOP HPC FLOOR T** to be poured later. The pitch of the bars along the joists and the depth they go into the joists must be defined when calculating the strengthening package.
- Bend the part of the bars protruding from the joists at 90° so they become embedded when **PLANITOP HPC FLOOR** or **PLANITOP HPC FLOOR T** fibre-reinforced mortar is placed (photo B).
- Pour the additional layer of **PLANITOP HPC FLOOR** or **PLANITOP HPC FLOOR T** mortar on the extrados to a depth of at least 25 mm (photos C and D).



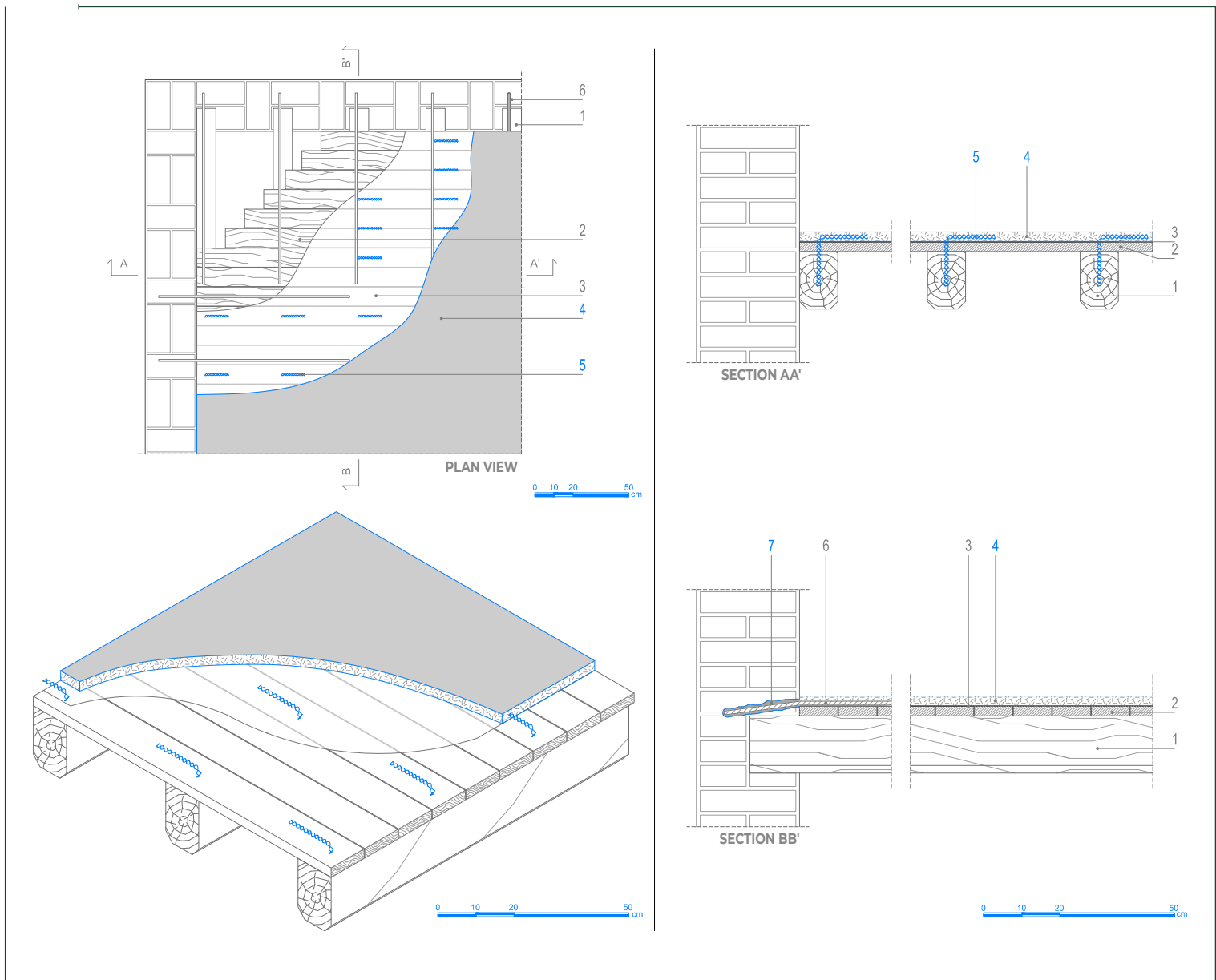

↓ NOTES

1. Use the **MAPEI STRUCTURAL DESIGN** calculation tool, which is compliant with CNR DT 204 guidelines, to define the thickness required for the layer of **PLANITOP HPC FLOOR**.
2. If the floor has a slope, it is recommended to use **PLANITOP HPC FLOOR T**.
3. Strengthening work using **PLANITOP HPC FLOOR / FLOOR T** does not require the use of electro-welded mesh.
4. The thickness of the layer of **PLANITOP HPC FLOOR / FLOOR T** must be calculated by a design engineer.
5. **PLANITOP HPC FLOOR** and **PLANITOP HPC FLOOR T** meet the requirements of EN 1504-3 for R4 class structural mortar and are covered by Technical Evaluation Certificate (CVT) according to guideline No. 220, 09/07/2015 and the following No. 293, 29/05/2019 issued by the Supreme Council of Public Works.

SCAN THE QR CODE

To download strengthening Data sheets, Technical data sheets, DWG, structural calculation software and other useful tips

or **DOWNLOAD FROM OUR WEBSITE**
www.rinforzo-strutturale.it



STRENGTHENING OF THE EXTRADOS OF FLOOR SLABS WITH A LOW THICKNESS STRUCTURAL SCREED

STRENGTHENING MIXED-TYPE FLOOR SLABS WITH HPC SYSTEM

STRUCTURAL SCREED: PLANITOP HPC FLOOR

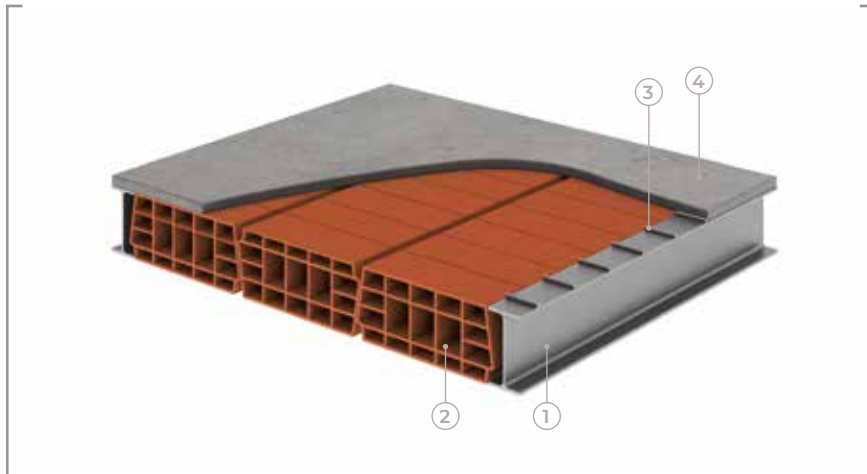

- ←
- 1 | STEEL H-BEAM
 - 2 | HOLLOW-CORE BRICK TILES / CAP
 - 3 | METAL CONNECTORS
 - 4 | PLANITOP HPC FLOOR

APPLICATION PROCEDURE

Mixed floors may be strengthened by applying a low thickness structural screed made from **PLANITOP HPC FLOOR** or **PLANITOP HPC FLOOR T**.

SUBSTRATE PREPARATION

Prepare the surfaces to be strengthened as follows:

- Remove all existing flooring and clean all the surfaces to be strengthened. Remove any loose or detached parts until the substrate is sound, compact and mechanically strong so that the materials applied afterwards do not become detached.
- Sand the extrados of the H-beams so they have a rough surface.
- Remove all loose material from the surfaces to be restored with a vacuum cleaner.

STATIC STRENGTHENING FOR FLOOR SLABS

- Insert steel rebars made from B450C into holes drilled into the wall around the floor, parallel to the H-beams, and anchor them in place with **MAPEFIX VE SF** (photo A).
- Attach a series of metal “L” connectors along the extrados of the H-beams (choose the size to suit directly on site, e.g. metal profiles 15 mm or 20 mm long), or a series of similar size pieces of round bar. The pitch of the connectors must be defined according to specific dimensions. Apply a coat of **EPORIP** epoxy resin along the steel joists and broadcast the resin while still fresh with dry **QUARTZ 1.2** sand so there is a rough interface with the strengthening package (photo B).
- Once the **EPORIP** has fully set, consolidate the extrados of the bricks with **PRIMER 3296** high-penetration acrylic primer and consolidator in water dispersion diluted 1:1 with water. This operation must be carried out at least 4 hours before pouring the mortar (photo C).
- Pour the additional layer of **PLANITOP HPC FLOOR** mortar on the extrados to a depth of around 20-25 mm (photo D).



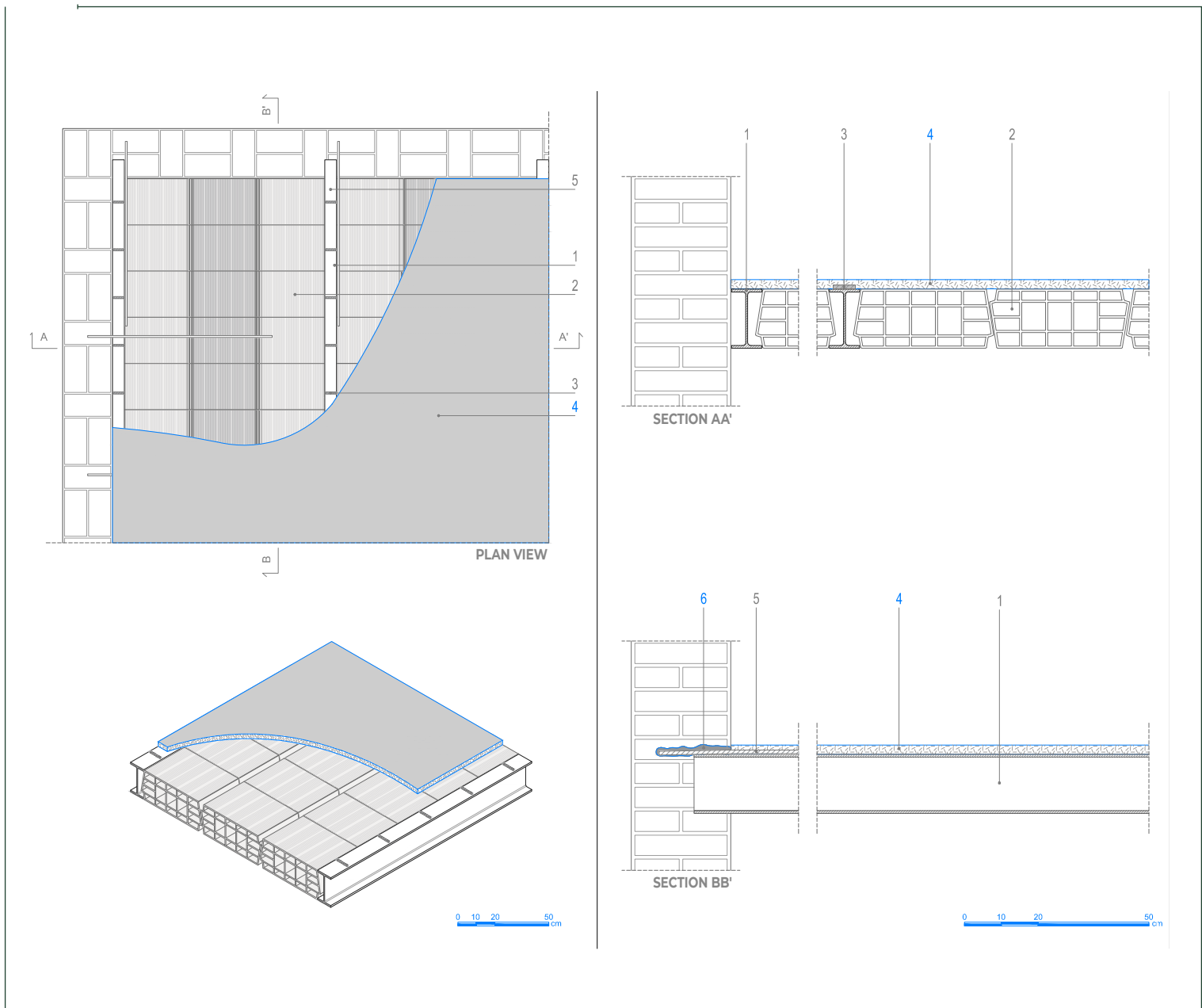

↓ NOTES

1. **PLANITOP HPC FLOOR** is a two-component, free-flowing, highly plastic ready-mixed mortar. For sloping floors, it is recommended to use **PLANITOP HPC FLOOR T** one-component, semi-plastic, ready-mixed mortar.
2. **PLANITOP HPC FLOOR / FLOOR T** contain fibres and have a high level of tensile strength which means no electro-welded mesh is required when carrying out strengthening work.
3. The thickness of the layer of **PLANITOP HPC FLOOR / FLOOR T** must be calculated by a design engineer.
4. **PLANITOP HPC FLOOR / FLOOR T** comply with the requirements of EN 1504-3 for R4 class structural mortar and are covered by the Technical Evaluation Certificate (CVT), D.P.C.S.LL.PP. No. 208, 09/04/2019.

SCAN THE QR CODE

To download strengthening Data sheets, Technical data sheets, DWG, structural calculation software and other useful tips

or **DOWNLOAD FROM OUR WEBSITE**
www.rinforzo-strutturale.it



2.3

STRENGTHENING SYSTEMS

FOR NON-LOAD-BEARING ELEMENTS

Collapse mechanisms of non-load-bearing elements (partition walls, buffer walls and ceilings) were not sufficiently covered in old building standards and targeted interventions need to be carried out to eliminate their original deficiencies because, if they are not corrected, there is the risk that a structural analysis that does not take them into consideration could be invalidated.

The following are the main types of intervention that can be carried out on non-load-bearing elements which, because of their weight and position (such as in the case of a collapsed ceiling with debris and bricks from floor falling to the floor below), are a potential hazard and safety risk for people in a building.

TYPICAL COLLAPSE MECHANISMS OF NON-LOAD-BEARING ELEMENTS



Localised interaction between buffer walls and the reinforced concrete frame



Overturning of internal partition walls



Collapse of external buffer walls



Internal cracks



Shear failure of partition walls



Targeted interventions are required to counteract the risk of collapse of non-load-bearing elements



STRENGTHENING SYSTEMS

FOR NON-LOAD-BEARING ELEMENTS

1. REPAIRING CRACKS IN BUFFER WALLS AND PARTITION WALLS

- 1.a  Localised crack-repair by applying a low thickness reinforced skim-coat: FRCM SYSTEM

2. OVERTURNING PREVENTING SYSTEMS FOR BUFFER WALLS AND PARTITION WALLS

- 2.a  Global prevention of overturning and collapse:
MAPEWRAP EQ SYSTEM
- 2.b  Localised prevention of overturning with a low thickness reinforced skim-coat: FRCM SYSTEM
-

3. ANTI-COLLAPSE SYSTEMS FOR CEILINGS

3.a  Global prevention of collapse of rendered ceilings with
MAPEWRAP EQ SYSTEM

3.b  Restoration and safety measures ceilings at risk of collapse by
applying a low thickness skim-coat: FRCM SYSTEM

REPAIRING CRACKS IN BUFFER WALLS AND PARTITION WALLS LOCALISED CRACK-REPAIR BY APPLYING A LOW THICKNESS REINFORCED SKIM-COAT: FRCM SYSTEM

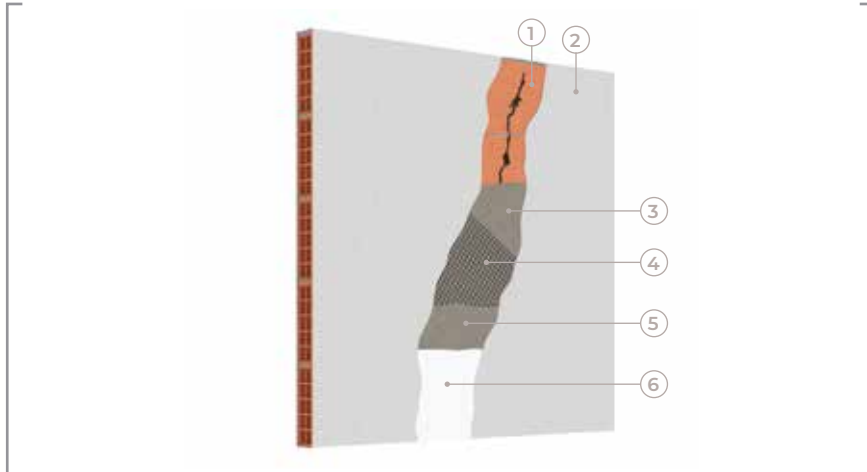

- 1 | EXISTING PARTITION/BUFFER WALL
- 2 | EXISTING RENDER
- 3 | PLANITOP HDM MAXI
- 4 | MAPEGRID G 120
- 5 | PLANITOP HDM MAXI
- 6 | SKIM-COAT

APPLICATION PROCEDURE



Localised repair and strengthening work on cracks in partition and buffer walls may be carried out by applying a “localised reinforced low thickness skim-coat” consisting of **MAPEGRID G 120** mesh from the **FRCM SYSTEM** line in combination with **PLANITOP HDM MAXI** two-component, high-ductility, fibre-reinforced mortar.

Proceed as follows:

- Remove all the existing render from around the crack to form an area around 50 cm wide (photo A).
- Remove any loose material from the surface (photo B).
- Rinse the surface with water to leave a damp substrate before carrying out the next steps (photo C).
- Apply a layer around 5-6 mm thick of **PLANITOP HDM MAXI** two-component, high-ductility, fibre-reinforced mortar (photo D).
- While the mortar is still fresh, place **MAPEGRID G 120** A.R. alkali-resistant glass fibre mesh around and over the crack so that it covers the 50 cm area created in the previous step (photo E).
- Apply a second layer around 5-6 mm thick of **PLANITOP HDM MAXI** while the first layer is still fresh (photo F).
- Once the **PLANITOP HDM MAXI** is fully cured, skim the surface with a skimming product from the **PLANITOP** range (photo G).



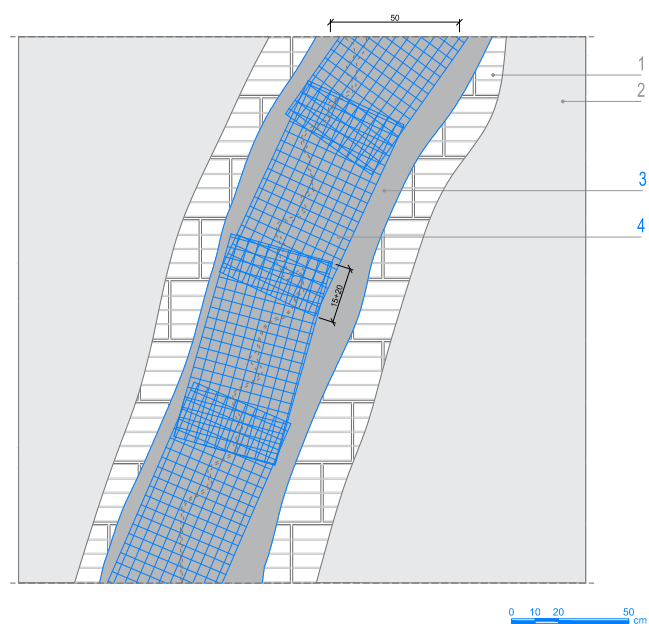
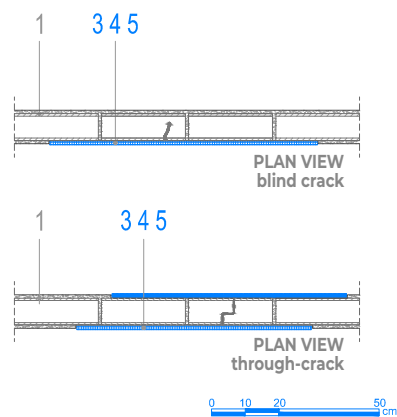
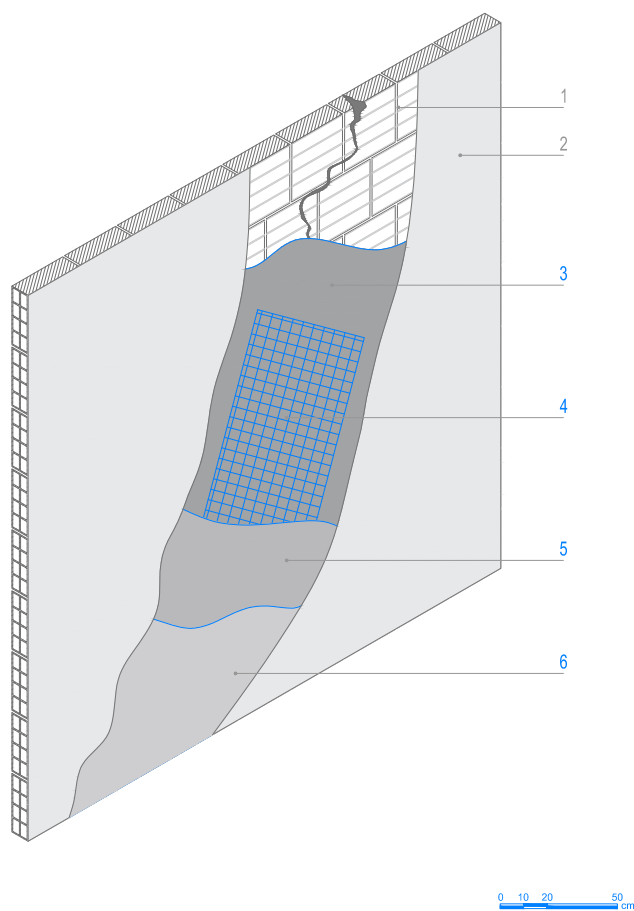

↓ NOTES

1. **PLANITOP HDM MAXI** is a two-component, high-ductility, fibre-reinforced mortar containing Pozzolan-reaction binders.
2. **PLANITOP HDM MAXI** complies with the requirements of EN 998-1 as GP type CS IV class render, of EN 998-2 for M25 masonry mortar and the requirements of EN 1504-3 for R2 class non-structural mortar.

SCAN THE QR CODE

To download strengthening Data sheets, Technical data sheets, DWG, structural calculation software and other useful tips

or **DOWNLOAD FROM OUR WEBSITE**
www.rinforzo-strutturale.it



OVERTURNING PREVENTING SYSTEMS FOR BUFFER WALLS AND PARTITION WALLS

GLOBAL PREVENTION OF OVERTURNING AND COLLAPSE:

MAPEWRAP EQ SYSTEM

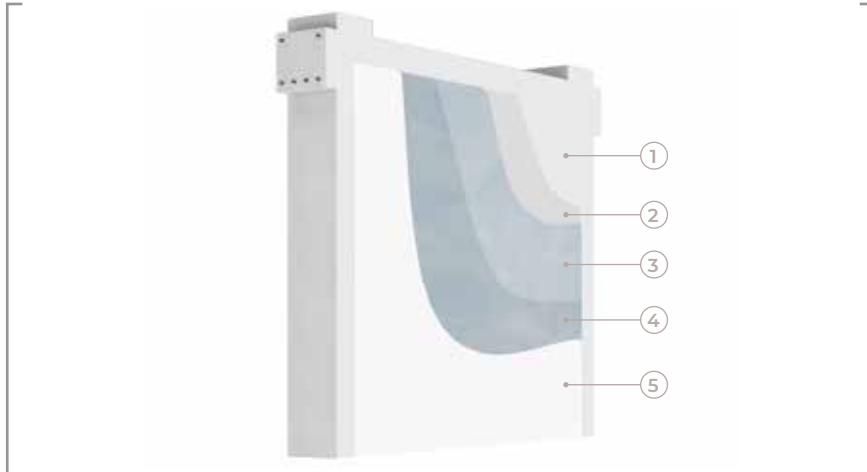

APPLICATION PROCEDURE



MAPEWRAP EQ SYSTEM is a system applied over existing render (as long as it is firmly attached to the substrate) to prevent partition walls and buffer walls from tipping over.

Proceed as follows:

- Remove all paint down to the surface of the existing render. This operation must be carried out on the walls and must be extended for at least the first 10 cm of the ceiling. Remove and repair any areas of loose or crumbling render (photo A).
- Apply a coat of **MAPEWRAP EQ ADHESIVE** with a roller over the entire surface of the walls and for at least the first 10 cm of the ceiling (photo B).
- Place **MAPEWRAP EQ NET** two-directional glass fibre fabric over the adhesive while it is still fresh; overlap the pieces of fabric by at least 10-15 cm. The fabric must also extend onto the ceiling for at least 10 cm (photo C).
- Apply a second coat of **MAPEWRAP EQ ADHESIVE** while the first coat is still fresh so that it completely impregnates the strengthening fabric (photo D).
- 24 hours after applying **MAPEWRAP EQ SYSTEM**, skim the surface with **PLANITOP 200** (photos E and F).

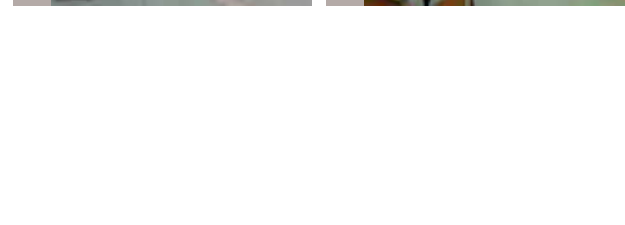
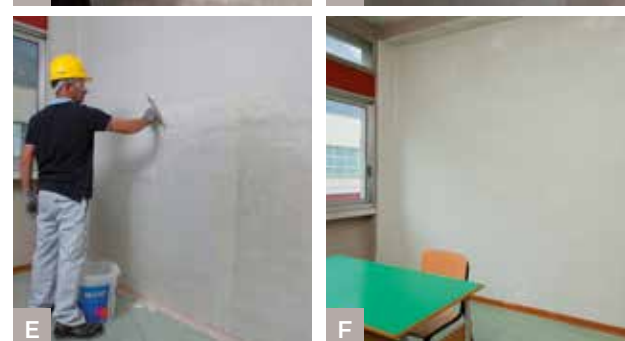
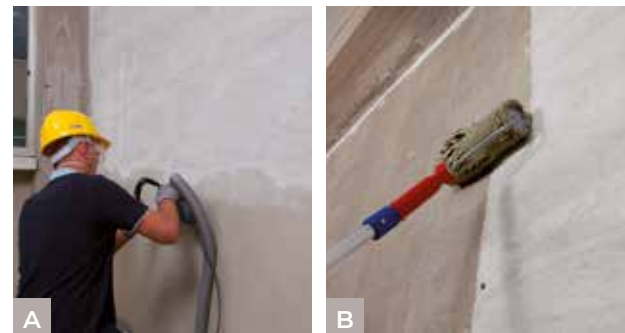

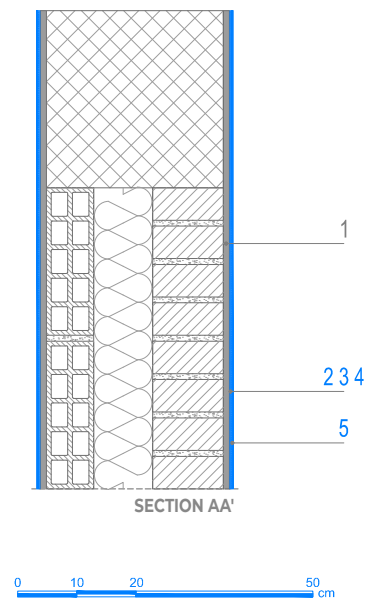
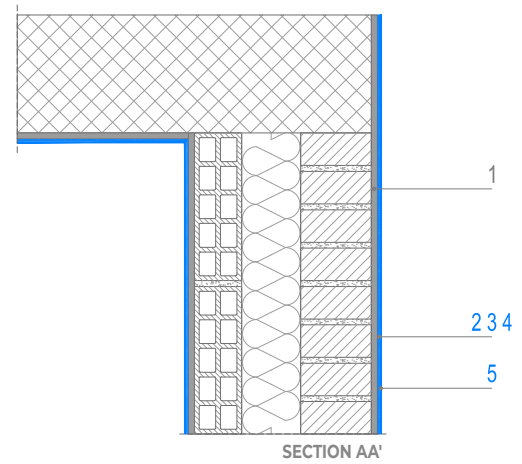
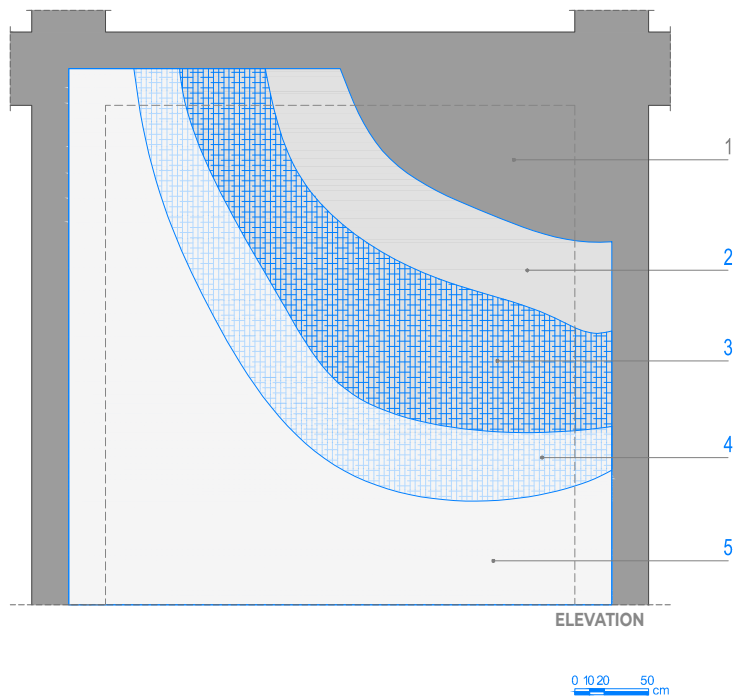

SCAN THE QR CODE

To download strengthening Data sheets, Technical data sheets, DWG, structural calculation software and other useful tips

or **DOWNLOAD FROM OUR WEBSITE**
www.rinforzo-strutturale.it



OVERTURNING PREVENTING SYSTEMS FOR BUFFER WALLS AND PARTITION WALLS

LOCALISED PREVENTION OF OVERTURNING WITH A LOW THICKNESS REINFORCED SKIM-COAT: FRCM SYSTEM (PART A)

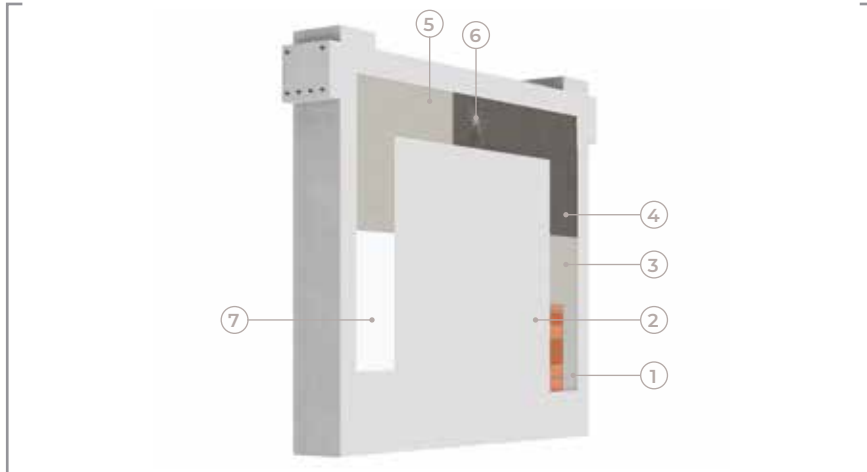

- 1 | EXISTING PARTITION/BUFFER WALL
- 2 | EXISTING RENDER
- 3 | PLANITOP HDM MAXI
- 4 | MAPEGRID G 120
- 5 | PLANITOP HDM MAXI
- 6 | MAPEWRAP SG FIOCCO
- 7 | SKIM-COAT

APPLICATION PROCEDURE



To prevent buffer and partition walls from tipping over after an earthquake, apply a series of bands over the joint between the reinforced structure and the buffer and partition walls using products from the **MAPEI FRCM SYSTEM** line.

Proceed as follows:

- Remove the existing render between the buffer/partition wall and the floor/beam to form an area of around 50 cm, or 25 cm each side of the joint.
- Drill a series of holes through the buffer or partition wall where the $\varnothing 16$ mm connectors will be inserted and seal the holes temporarily with a removable marker.
- Remove any loose material from the surface and rinse with water at low-pressure to leave the surface damp before carrying out the next steps (photo A).
- Apply a layer around 5-6 mm thick of **PLANITOP HDM MAXI** two-component, high-ductility, fibre-reinforced mortar (photo B).
- Place **MAPEGRID G 120** A.R. alkali-resistant, primed glass fibre mesh over the buffer (or partition) wall so that it covers the 50 cm area created previously (photo C).
- Apply a second layer around 5-6 mm thick of **PLANITOP HDM MAXI** while the first layer is still fresh so that it completely covers the glass fibre mesh (photos D and E).



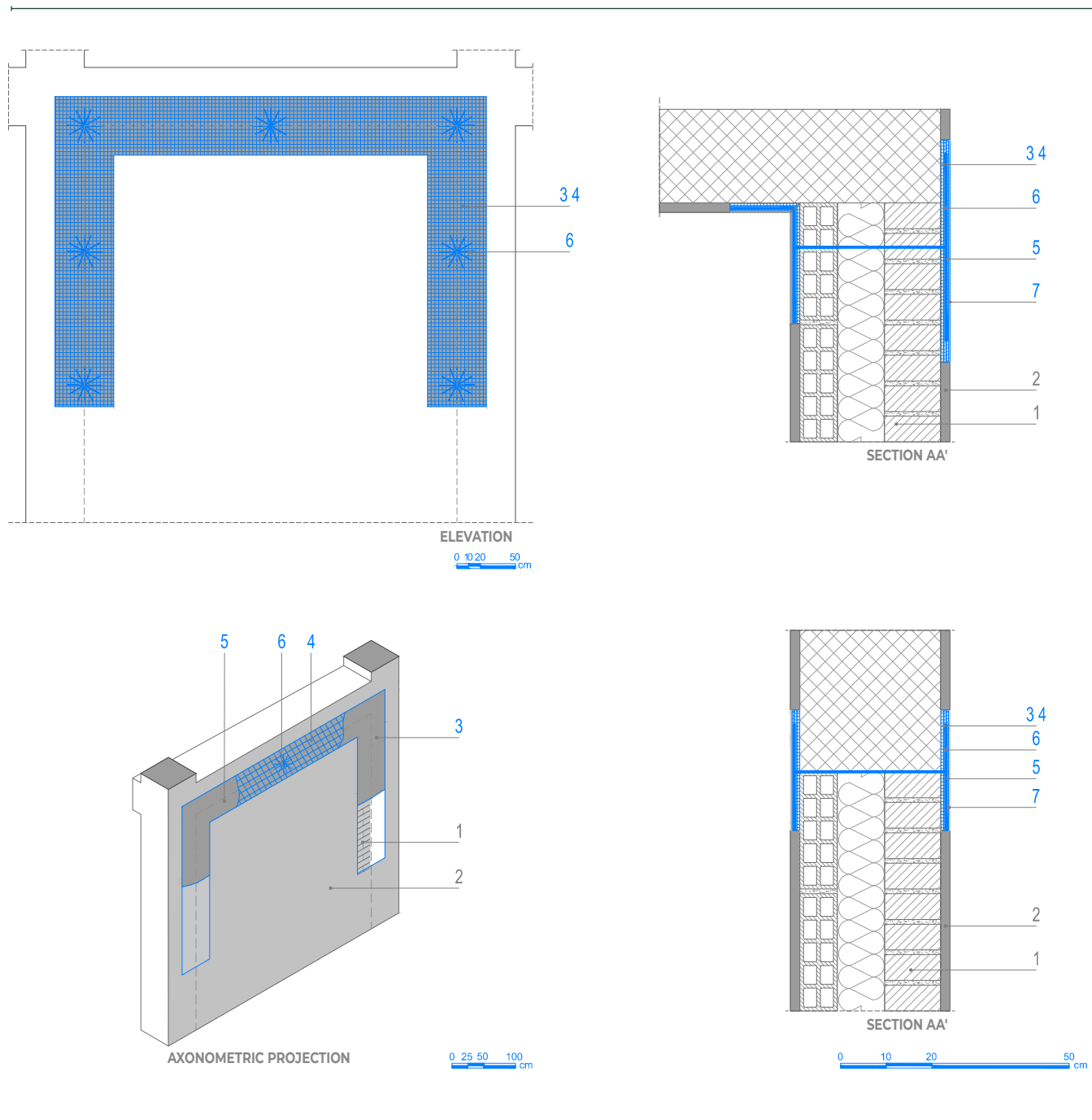

↓ NOTES

1. This type of intervention complies with the instructions in the "Guidelines for repairing and strengthening structural elements, buffer walls and partition walls" document issued by ReLUIS and the Civil Protection Department following the earthquake in L'Aquila in 2009.

SCAN THE QR CODE

To download strengthening Data sheets, Technical data sheets, DWG, structural calculation software and other useful tips

or **DOWNLOAD FROM OUR WEBSITE**
www.rinforzo-strutturale.it



OVERTURNING PREVENTING SYSTEMS FOR BUFFER WALLS AND PARTITION WALLS

LOCALISED PREVENTION OF OVERTURNING WITH A LOW THICKNESS REINFORCED SKIM-COAT: FRCM SYSTEM (PART B)

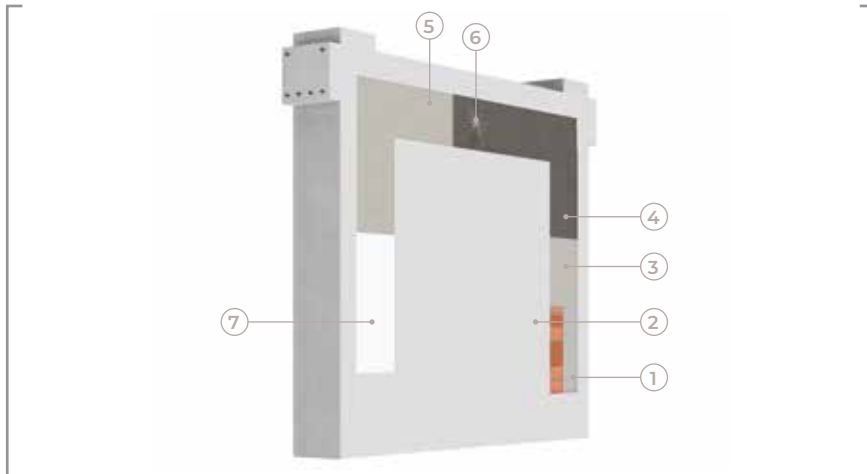

- 1 | EXISTING PARTITION/BUFFER WALL
- 2 | EXISTING RENDER
- 3 | PLANITOP HDM MAXI
- 4 | MAPEGRID G 120
- 5 | PLANITOP HDM MAXI
- 6 | MAPEWRAP SG FIOCCO
- 7 | SKIM-COAT

APPLICATION PROCEDURE



To **make the cord connectors** to complete the intervention, proceed as follows:

- Cut the **MAPEWRAP SG FIOCCO** high-strength galvanized steel fibre cord to the length required with a hand grinder. In the case of **through-type connectors**, the length of the cord should be equal to the thickness of the buffer/partition wall plus the amount required to form the two splayed ends (photo A).
- Remove the markers previously inserted in the holes (photo B).
- Remove any dust and loose material from the holes (photo C).
- Fill the holes in the wall with **MAPEFIX VE SF** or **MAPEFIX EP 385-585** vinyl ester chemical anchor for structural loads (photo D).
- Insert the **MAPEWRAP SG FIOCCO** into the holes (photo E).
- Splay out the ends of the **MAPEWRAP SG FIOCCO** on each side of the wall and impregnate them with **MAPEWRAP 11** or **12** (photo F).
- Broadcast the surface of the resin while still fresh with **QUARTZ 1.2** sand to form a good keying surface for the next materials (photo G).
- Wait until the **PLANITOP HDM MAXI** is fully cured and then skim the surface with a product from the **PLANITOP** range.



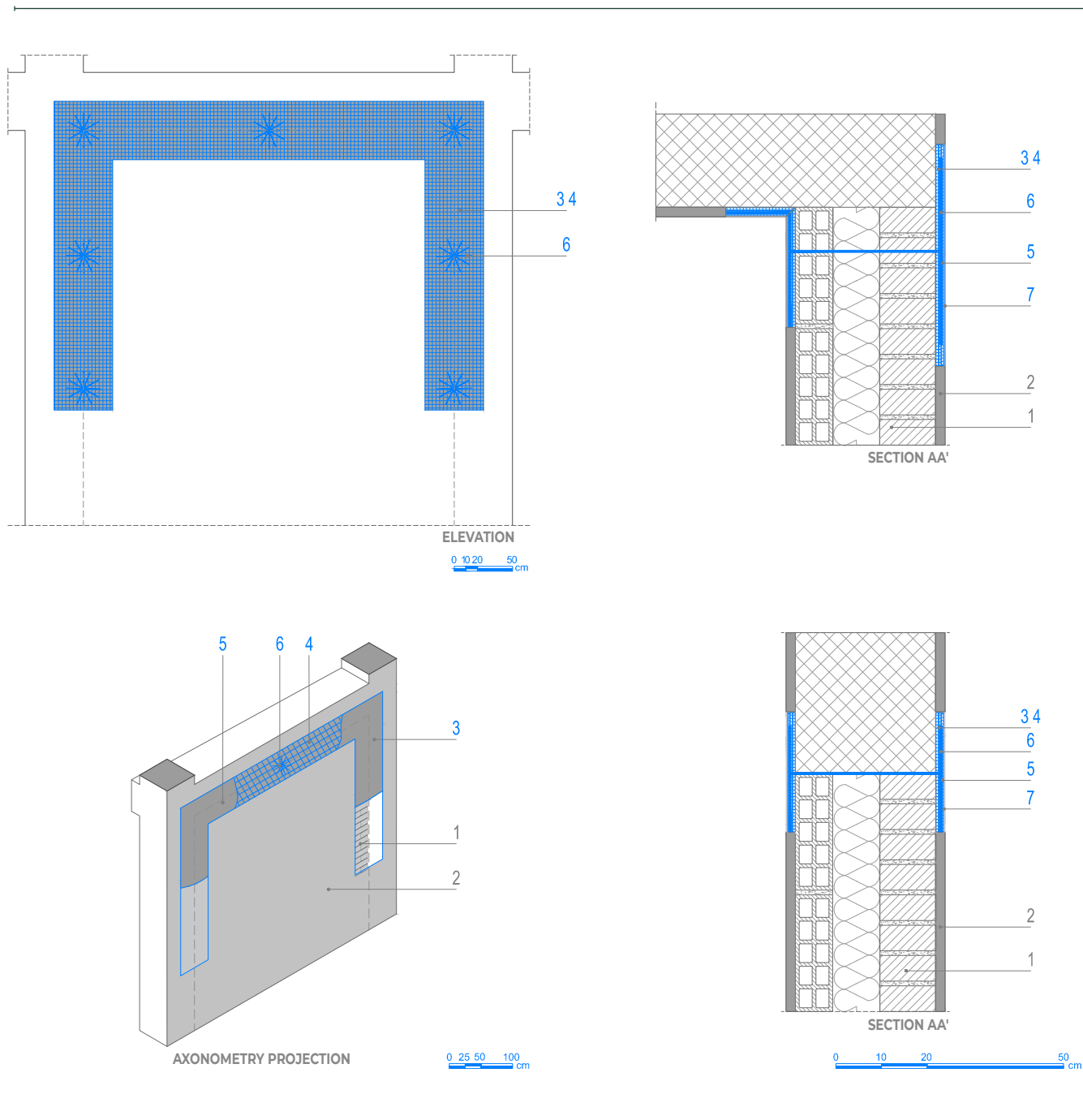

↓ NOTES

1. This type of intervention complies with the instructions in the "Guidelines for repairing and strengthening structural elements, buffer walls and partition walls" document issued by ReLUIS and the Civil Protection Department following the earthquake in l'Aquila in 2009.

SCAN THE QR CODE

To download strengthening Data sheets, Technical data sheets, DWG, structural calculation software and other useful tips

or **DOWNLOAD FROM OUR WEBSITE**
www.rinforzo-strutturale.it



ANTI-COLLAPSE SYSTEMS FOR CEILINGS

GLOBAL PREVENTION OF COLLAPSE OF RENDERED CEILINGS WITH MAPEWRAP EQ SYSTEM

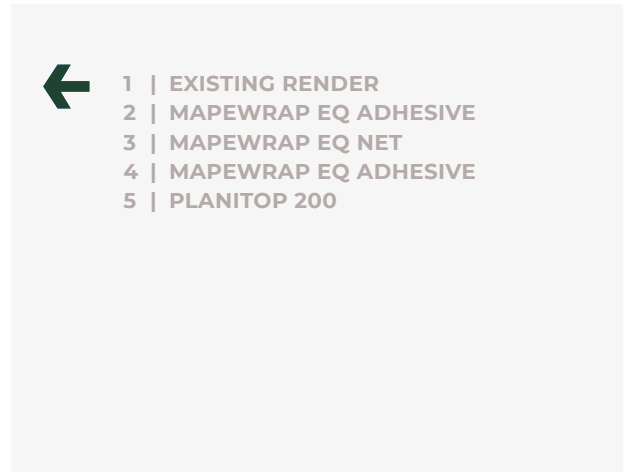
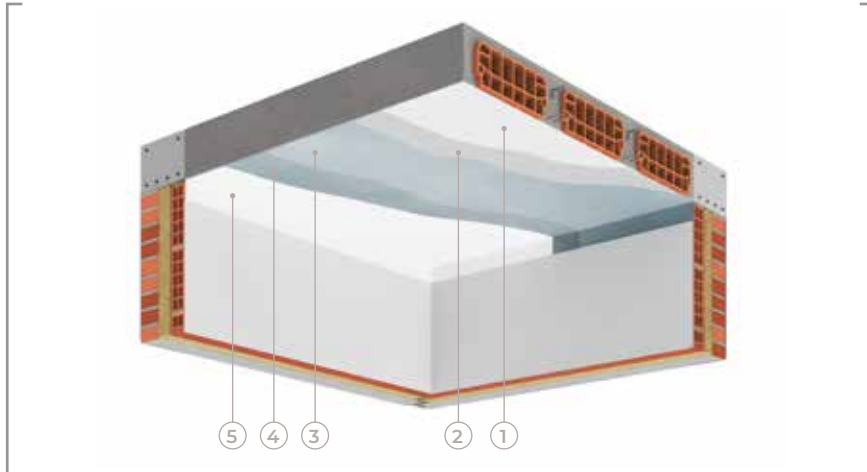

APPLICATION PROCEDURE



If the render is well attached to the ceiling, an anti-collapse system may be applied using the **MAPEWRAP EQ SYSTEM**.

Proceed as follows:

- Remove any paint from the ceiling down to the surface of the render. This operation must be extended for at least the first 10 cm of the walls. Remove and repair any areas of loose or crumbling render (photo A).
- Cut the fabric to length (photo B).
- Apply a coat of **MAPEWRAP EQ ADHESIVE** with a roller all over the ceiling and for at least the first 10 cm of the walls (photo B).
- Place **MAPEWRAP EQ NET** two-directional glass fibre fabric over the adhesive while it is still fresh; overlap the pieces of fabric by at least 10-15 cm. The fabric must also extend over at least the first 10 cm of the walls (photo E).
- Apply a second coat of **MAPEWRAP EQ ADHESIVE** while the first coat is still fresh so that it completely impregnates the strengthening fabric (photo F).
- 24 hours after applying **MAPEWRAP EQ SYSTEM**, skim the surface with **PLANITOP 200** (photo G).

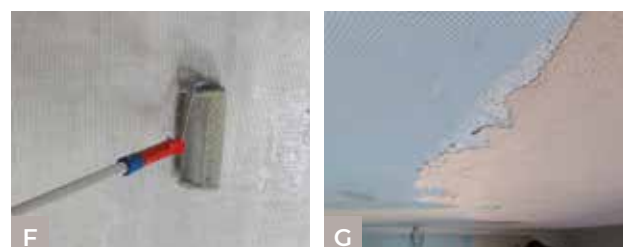
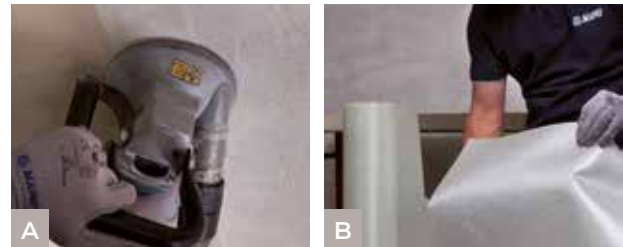

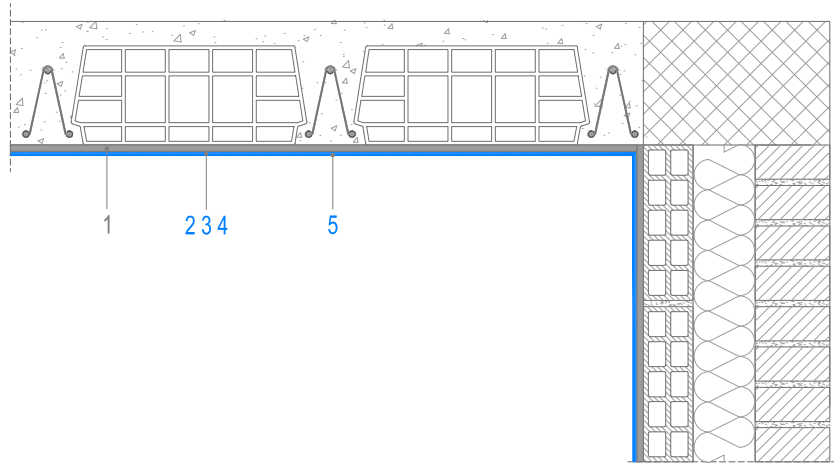

0 10 20 50 cm

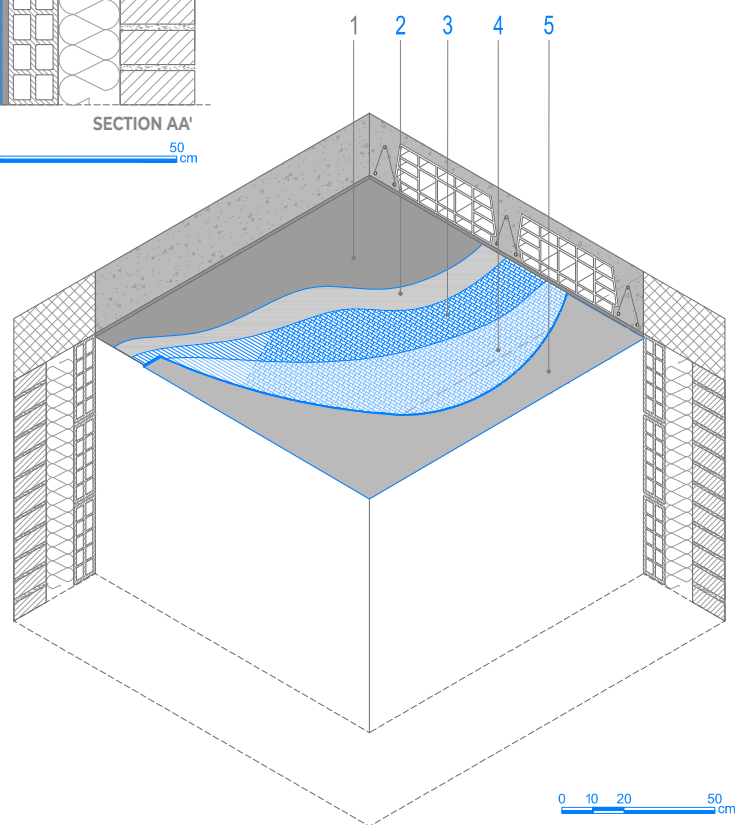

0 10 20 50 cm

SCAN THE QR CODE

To download strengthening Data sheets,
Technical data sheets, DWG, structural
calculation software and other useful tips

or **DOWNLOAD FROM OUR WEBSITE**
www.rinforzo-strutturale.it



ANTI-COLLAPSE SYSTEMS FOR CEILINGS

RESTORATION AND SAFETY MEASURES FOR LOW THICKNESS CEILINGS AT RISK OF COLLAPSE BY APPLYING A LOW THICKNESS SKIM-COAT:

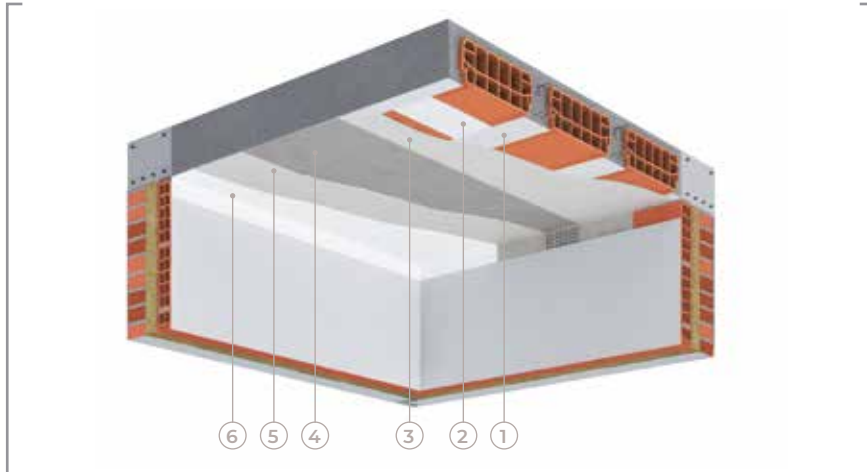

← **FRCM SYSTEM**

- 1 | EXISTING CEILING
- 2 | EPS PANEL BONDED WITH MAPETHERM ARI GG
- 3 | PLANITOP HDM MAXI
- 4 | MAPEGRID G 120
- 5 | PLANITOP HDM MAXI
- 6 | SKIM-COAT

APPLICATION PROCEDURE →

If there are clear signs of collapse and the render is not firmly attached to the substrate, and missing portions of hollow-core blocks need to be reintegrated, proceed as follows:

- Remove all loose blocks and brickwork and the existing render. Carry out a thorough inspection of the floor joists. Repair any joists that are damaged or badly deteriorated (SHEET 1.B RC) (photo A).
- Fill any collapsed areas where the hollow-core blocks are missing with polystyrene panels bonded with **MAPETHERM ARI** one-component cementitious adhesive and skimming compound or **MAPEPUR** polyurethane foam (photo B).
- Remove all loose material, vacuum off the dust and rinse with water at low-pressure to leave a damp surface before carrying out the next steps (photo C).
- Apply a layer around 4-5 mm thick of **PLANITOP HDM MAXI** two-component, high-ductility, fibre-reinforced mortar (photo D).
- Place **MAPEGRID G 120** A.R. alkali-resistant glass fibre mesh over the mortar while it is still fresh; make sure the pieces of mesh overlap by at least 10 cm (photo E).
- Apply a second layer around 4-5 mm thick of **PLANITOP HDM MAXI** while the first layer is still fresh so that the mesh is completely covered and is “working” at the mid-point of the two layers (photo F).
- Wait until the **PLANITOP HDM MAXI** is fully cured and then skim the surface with a product from the **PLANITOP** range.



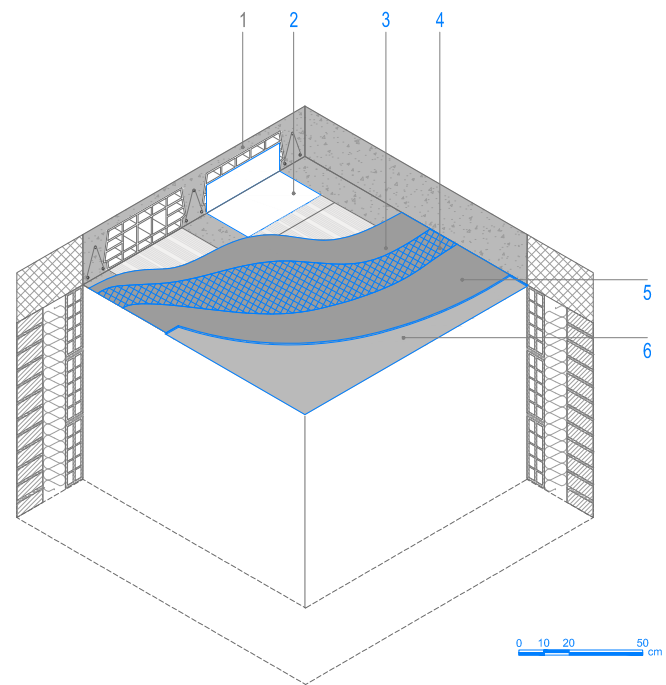
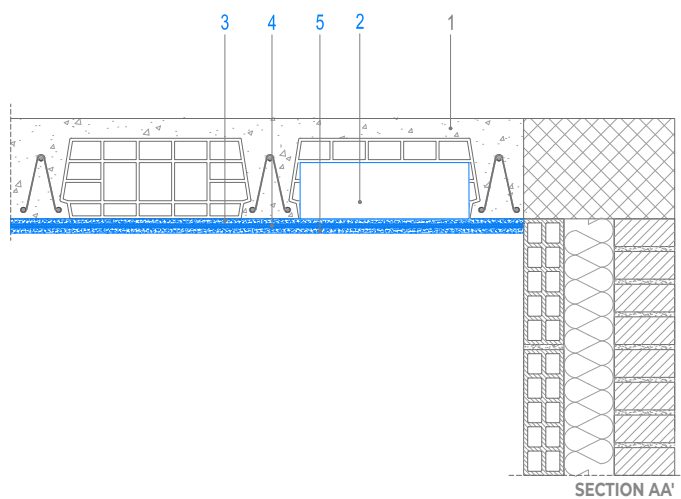
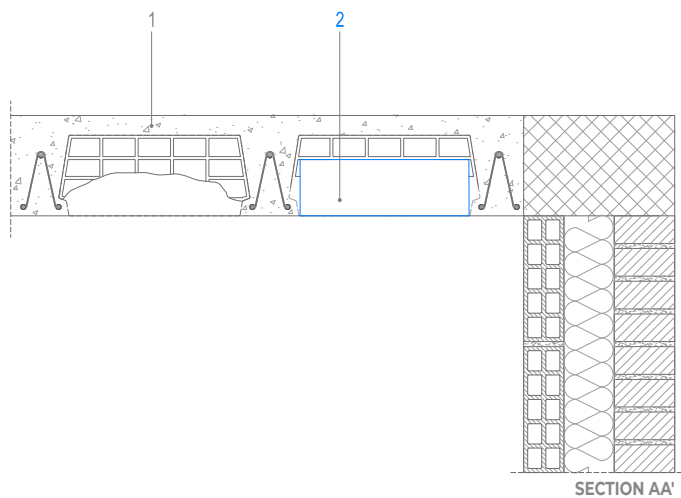

↓ NOTES

1. **PLANITOP HDM MAXI** is a two-component, high-ductility, fibre-reinforced mortar containing Pozzolan-reaction binders.
2. **PLANITOP HDM MAXI** complies with the requirements of EN 998-1 as GP type CS IV class render, of EN 998-2 for M25 masonry mortar and the requirements of EN 1504-3 for R2 class non-structural mortar.
4. **PLANITOP HPC FLOOR / FLOOR T** comply with the requirements of EN 1504-3 for R4 class structural mortar and are covered by the Technical Evaluation Certificate (CVT), D.P.C.S.LL.PP. No. 208, 09/04/2019.

SCAN THE QR CODE

To download strengthening Data sheets, Technical data sheets, DWG, structural calculation software and other useful tips

or **DOWNLOAD FROM OUR WEBSITE**
www.rinforzo-strutturale.it



